

FÖRKLARINGAR

- Fastighetsgräns
- Fasadliv byggnad
- Skärmtak/balkong o dyl
- Entré, byggnad

BET	ÄNDRINGEN AVSER	DATUM	SIGN

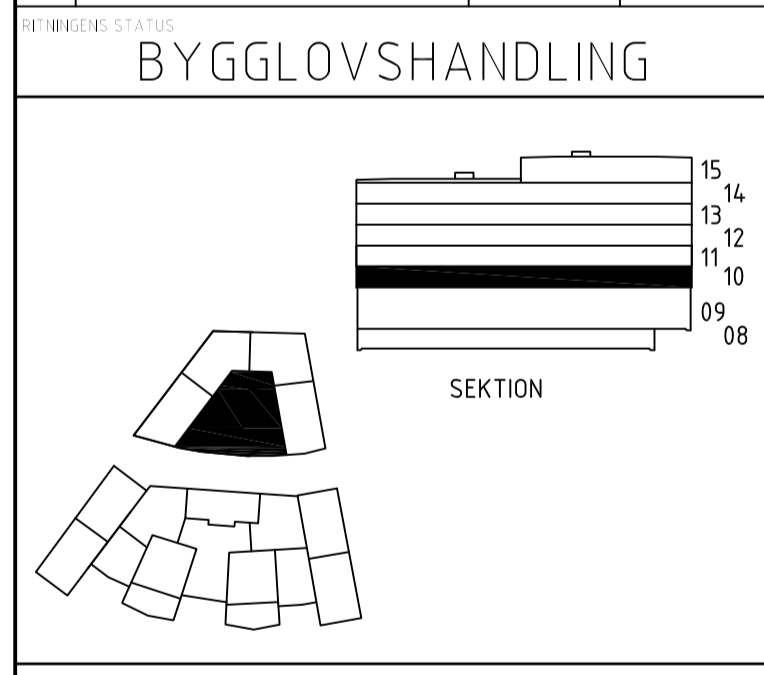

KVARNHOLMSTERRASSEN SICKLAÖN 38:27 - NYBYGGNAD BOSTÄDER

A	TOTAL Arkitektur & Utvärdering AB	TEL 08-4413600
K	Sören Lundgren Byggnadskontroll AB	TEL 08-706 45 50
V	TOT	TEL 08-547 022 00
V/S	TOT	TEL 08-547 022 00
F	Elektrotekniska Installations AB	TEL 08-516 91186
ZORN	an	TEL 0793-200 645

PROJEKT NR	BYGGLOV NR	BYGGLOVSTAD
18006	StTa	StTa
2019-12-11	StTa	

PROJEKT NÄMNDEN
L4
Situationsplan
Planritning

STAD PLAN	BYGGLOV	BET
A1 1:200		
A3 1:400	L-10.1-60001	

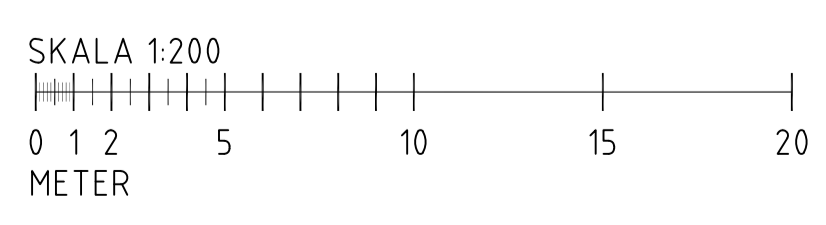

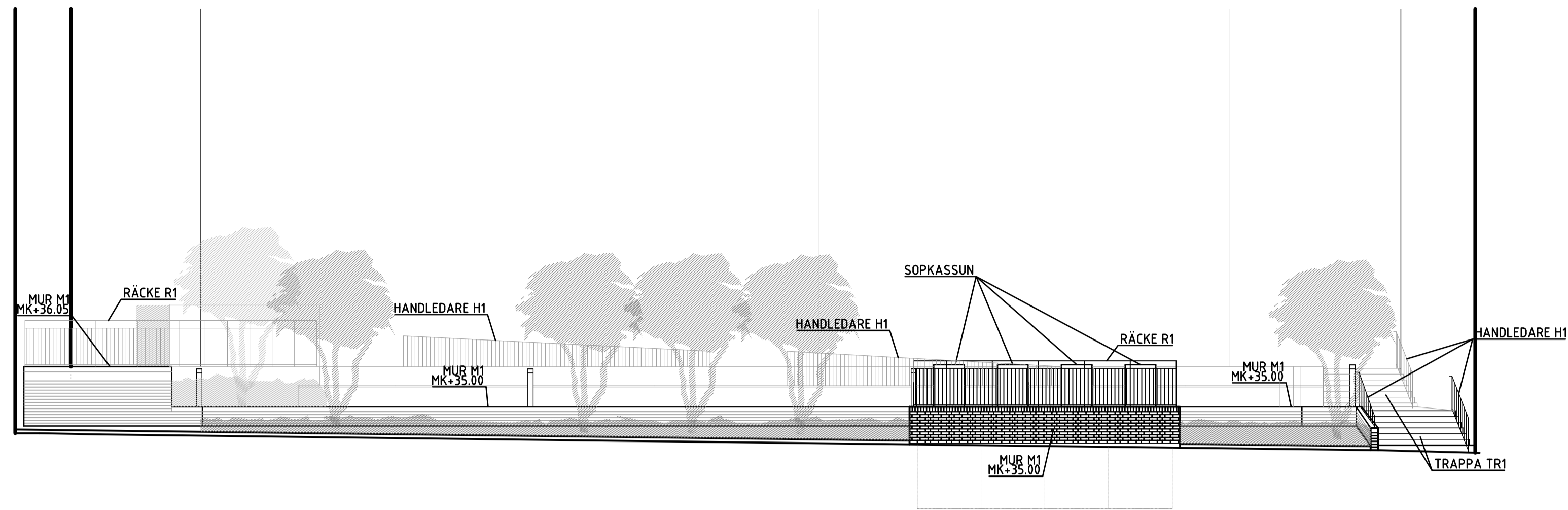

ELEVATION A-A

↔30.00

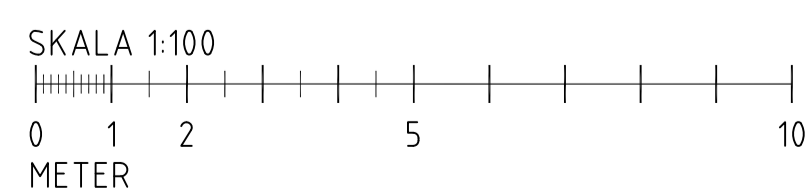

BET	ÄNDRINGEN AVSER	DATUM	SIGN
BYGGLOVSHANDLING			
PEAB			
KVARNHOLMSTERRASSEN SICKLAÖN 38:27 - NYBYGGNAD BOSTÄDER			
A	TOTAL Arkitektur & Urban AB	TEL 08-44136 00	
K	Sören Lundgren Byggnads AB	TEL 08-706 45 50	
V	TOT	TEL 08-567 022 00	
V/S	TOT	TEL 08-567 021 00	
F	Elektrotrade Installation AB	TEL 08-576 911 86	
ZORN	an	TEL 0793-390 645	
18006	StTa	StTa	
2019-12-11	StTa		
BYGGLOVSHANDLING			
L4			
A-A			
Elevation			
STYCKE A1 A3	BYGGLOVSHANDLING	BET	
A1	1:100	L-14.2-60001	
A3	1:200		

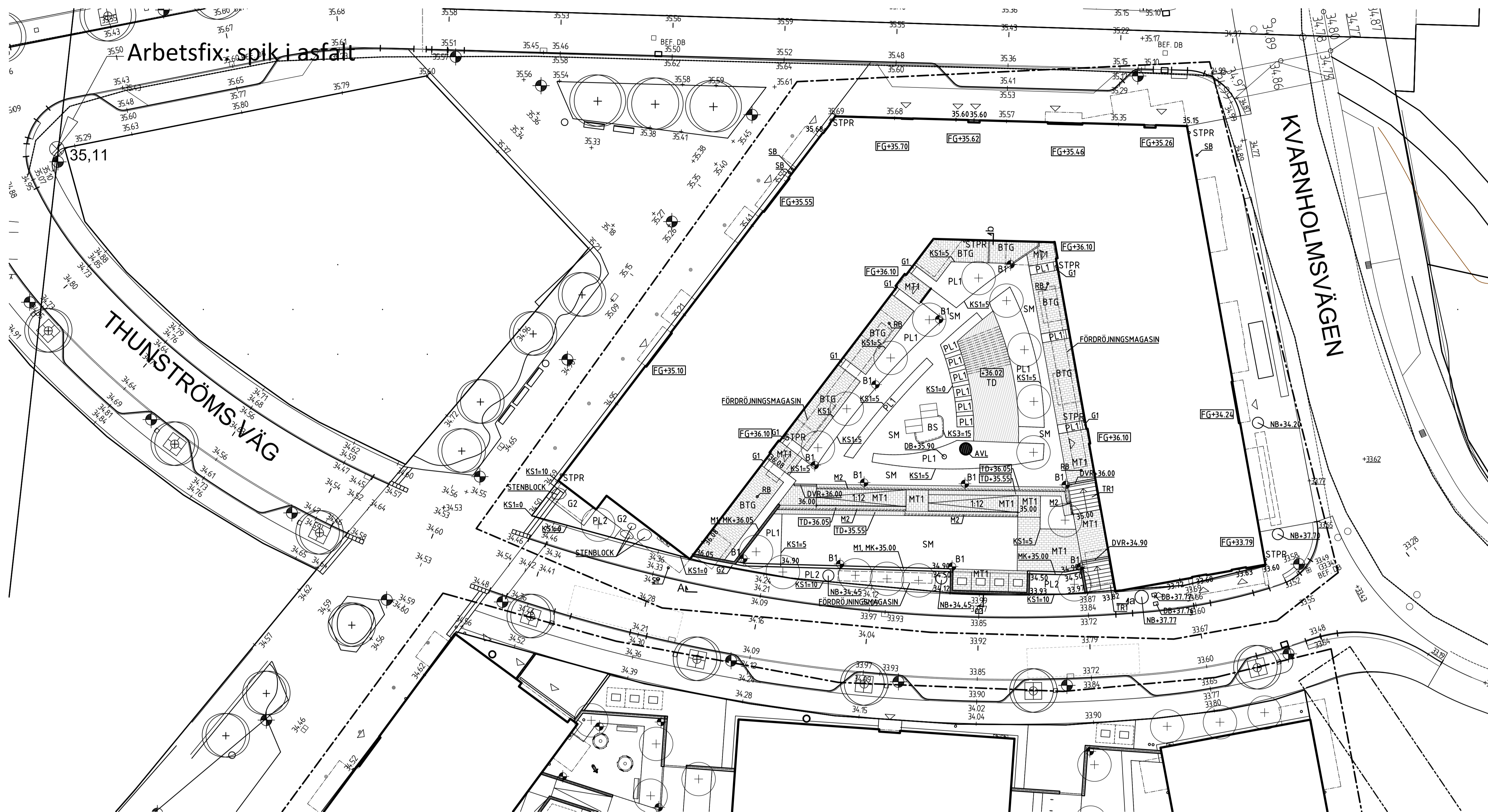

Arbetsfix: spik i asfalt

FÖRKLARINGAR

- Fastighetsgräns
- Fasadliv byggnad
- Skärmtak/balkong o dyl
- Entré, byggnad
- Markhöjd
- Nivå murkrön
- DB+00.00 Dagvattenbrunn
- Asfalt
- Betongplattor
- Marktegel
- Kross
- Baksand
- Trädäck
- Planteringsyta
- Stenmjöl
- Dagvattenbrunn
- Dagvattenränna
- Kantstöd, stål
- Kubbsarg
- Stuprör
- Stödmur marktegel
- L-stöd
- Trappa, marktegel
- AVL Avluftstorn, stål
- Fungämfyll pollararmatur ent. E.
- Träd, Buskträd/trädgröp
- Naturstenblock
- Sopkassun

FÖRESKRIFTER

Koordinatsystem SWEREF 99 18 00
Höjdssystem RH2000

BYGGLOVSHANDLING

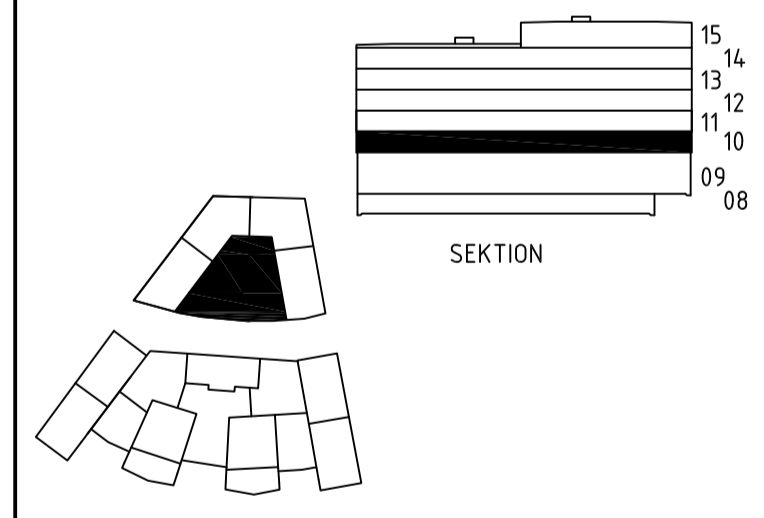

KVARNHOLMSTERRASSEN
SICKLAÖN 38:27 - NYBYGGNAD BOSTÄDER

A	TOTAL Arkitektur & Utvärdering AB	TEL 08-4413600
K	Sören Lundgren Byggnadsent AB	TEL 08-706 45 50
V	TOT	TEL 08-567 022 00
V.S	TOT	TEL 08-567 022 00
F	Elektrotekniska Installations AB	TEL 08-576 911 86
ZORN AB		TEL 0793-200 645

18006	StTa	StTa
2019-12-11	StTa	

Markplanering
Planritning

A1	1:200	
A3	1:400	L-16.1-60001

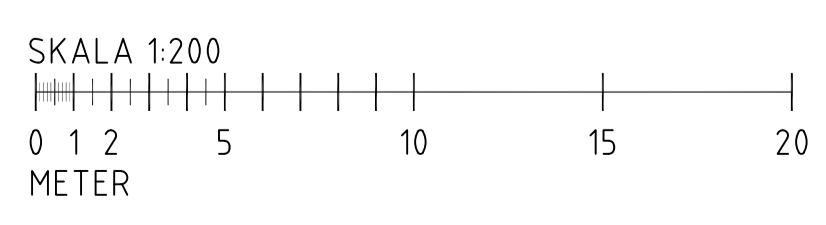

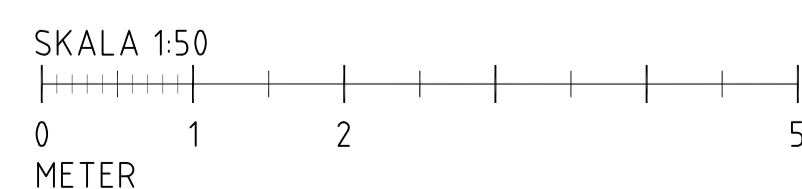
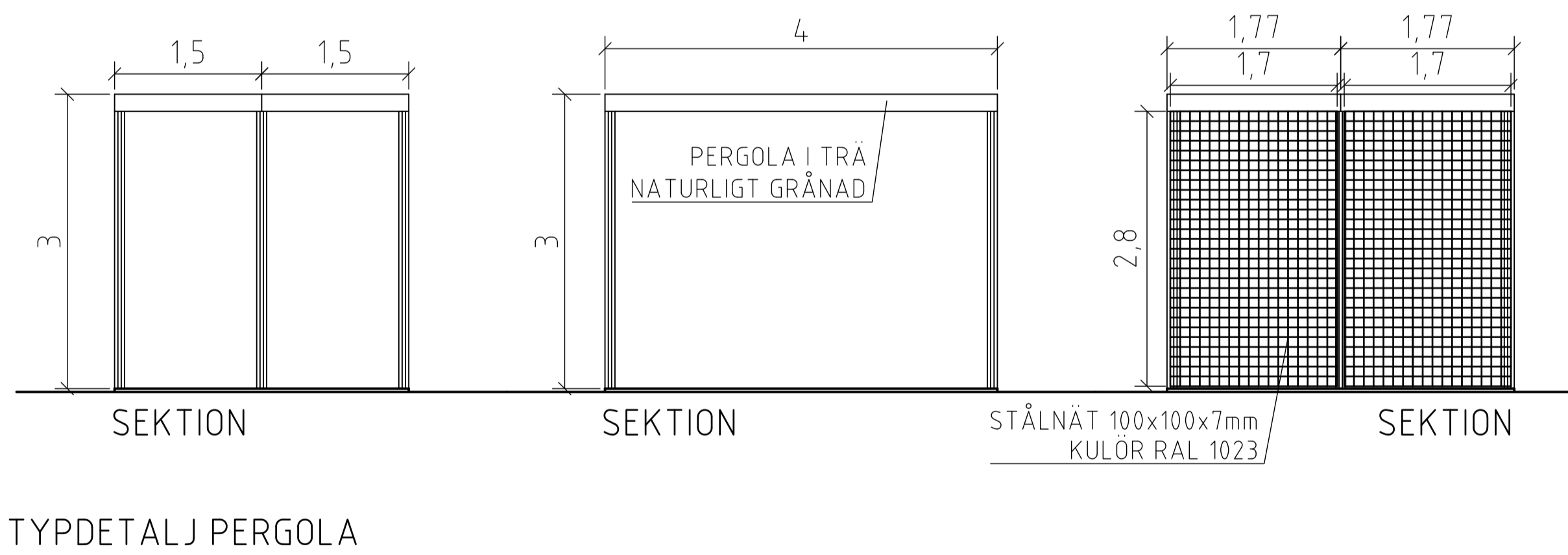
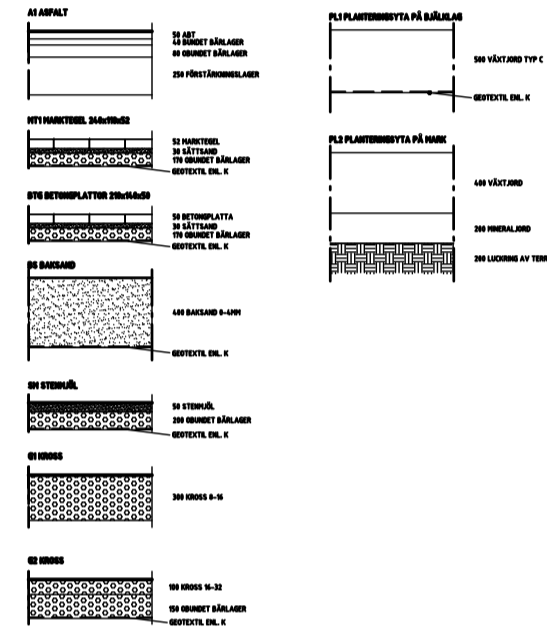
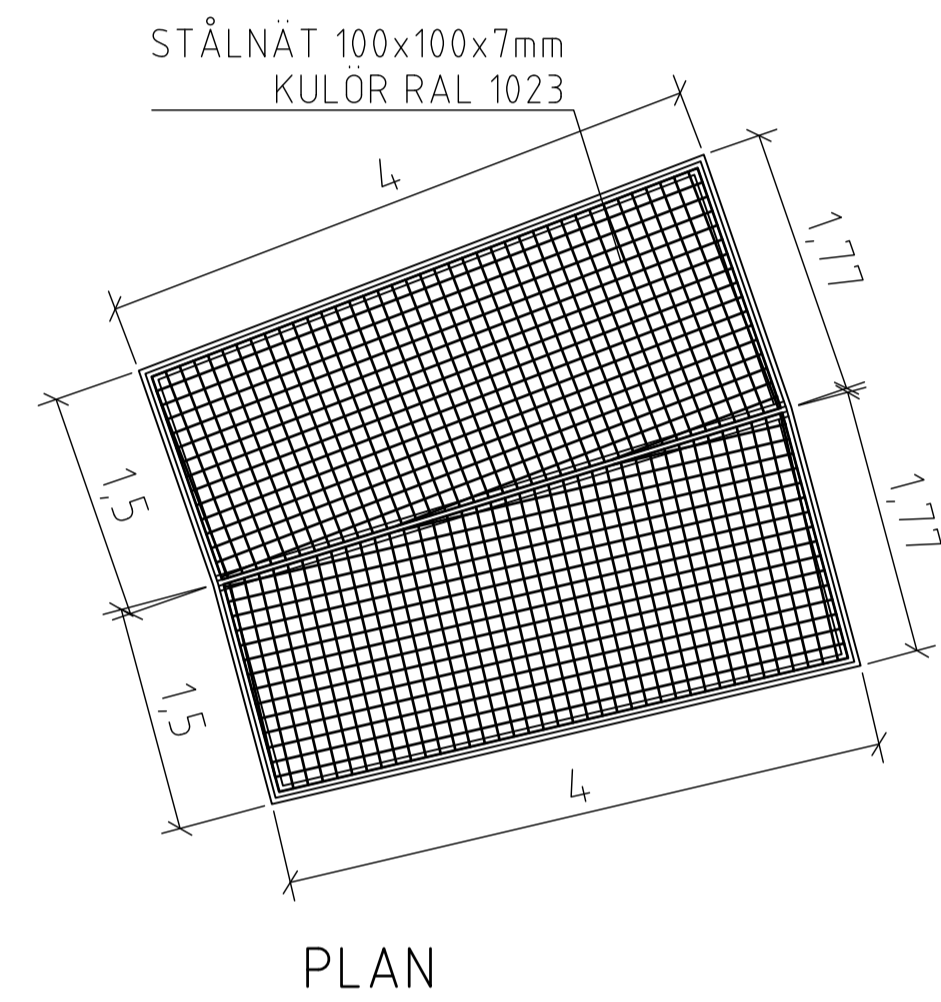
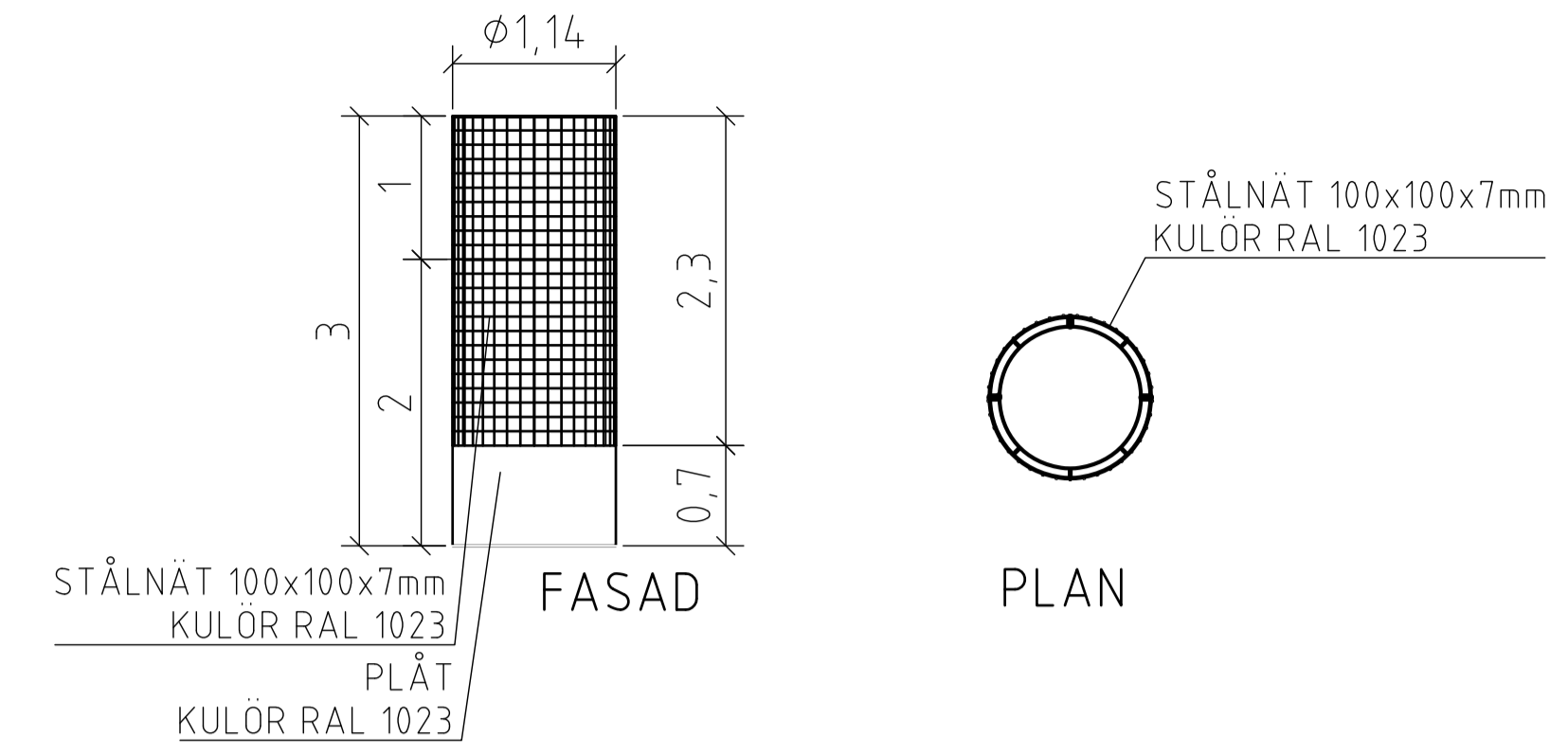
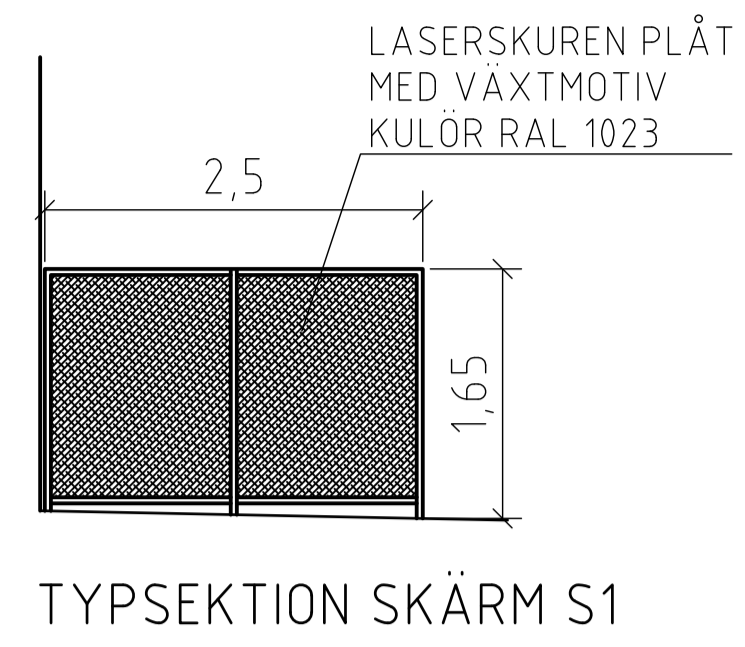
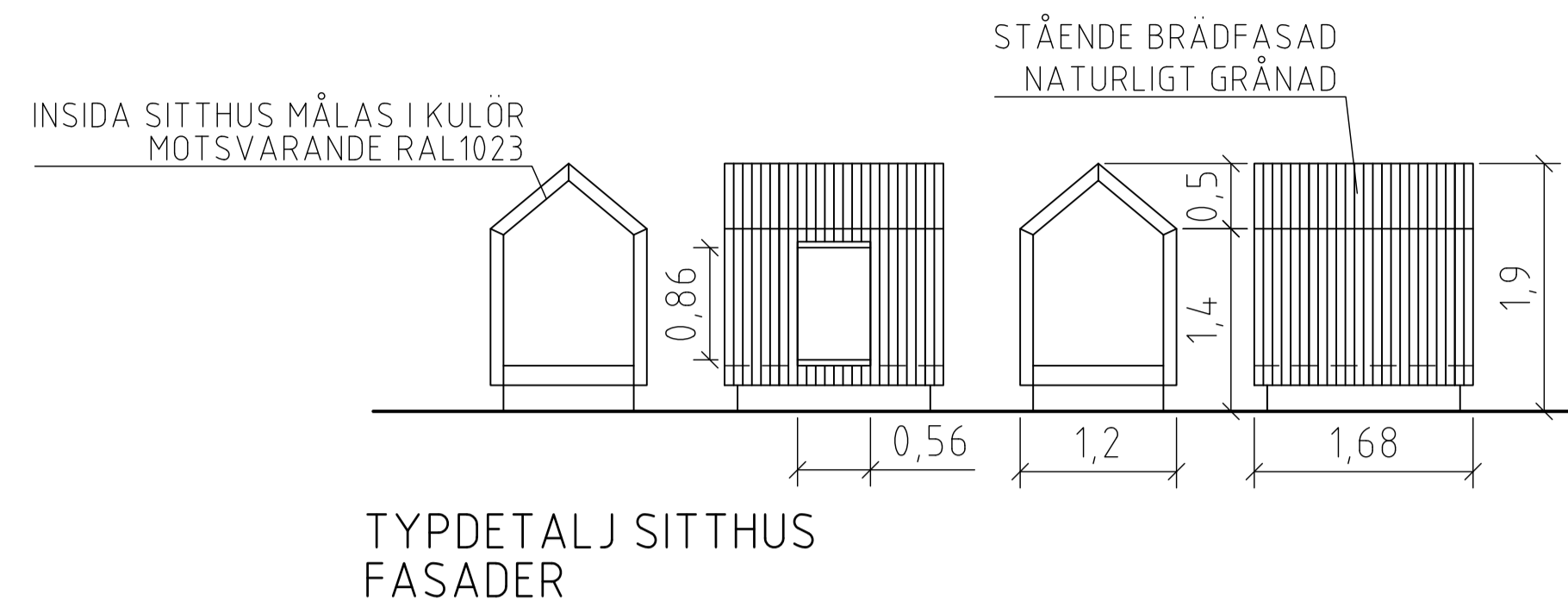

BET	ÄNDRINGEN AVSER	DATUM	SIGN
BYGGLOVSHANDLING			
KVARNHOLMSTERRASSEN SICKLAÖN 38:27 - NYBYGGNAD BOSTÄDER			
A	TOTAL Arkitektur & Utvärdering AB	TEL 08-4413600	
K	Sören Lundgren Byggnadskontroll AB	TEL 08-706 45 50	
V	TOT	TEL 08-567 022 00	
V/S	TOT	TEL 08-567 022 00	
F	Elektrotrade Installation AB	TEL 08-516 911 86	
ZORN	an	TEL 0793-330 645	
18006	StTa	StTa	
2019-12-11	StTa		
PERGOLA, SITTHUS, AVLÜFTSTORN, SKÄRM S1 Typdetaljer			
A1	1:50		
A3	1:100		
L-18.2-60001			BET

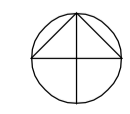
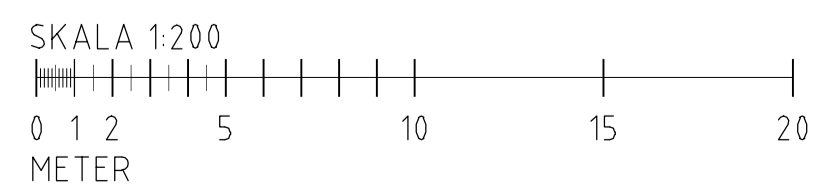
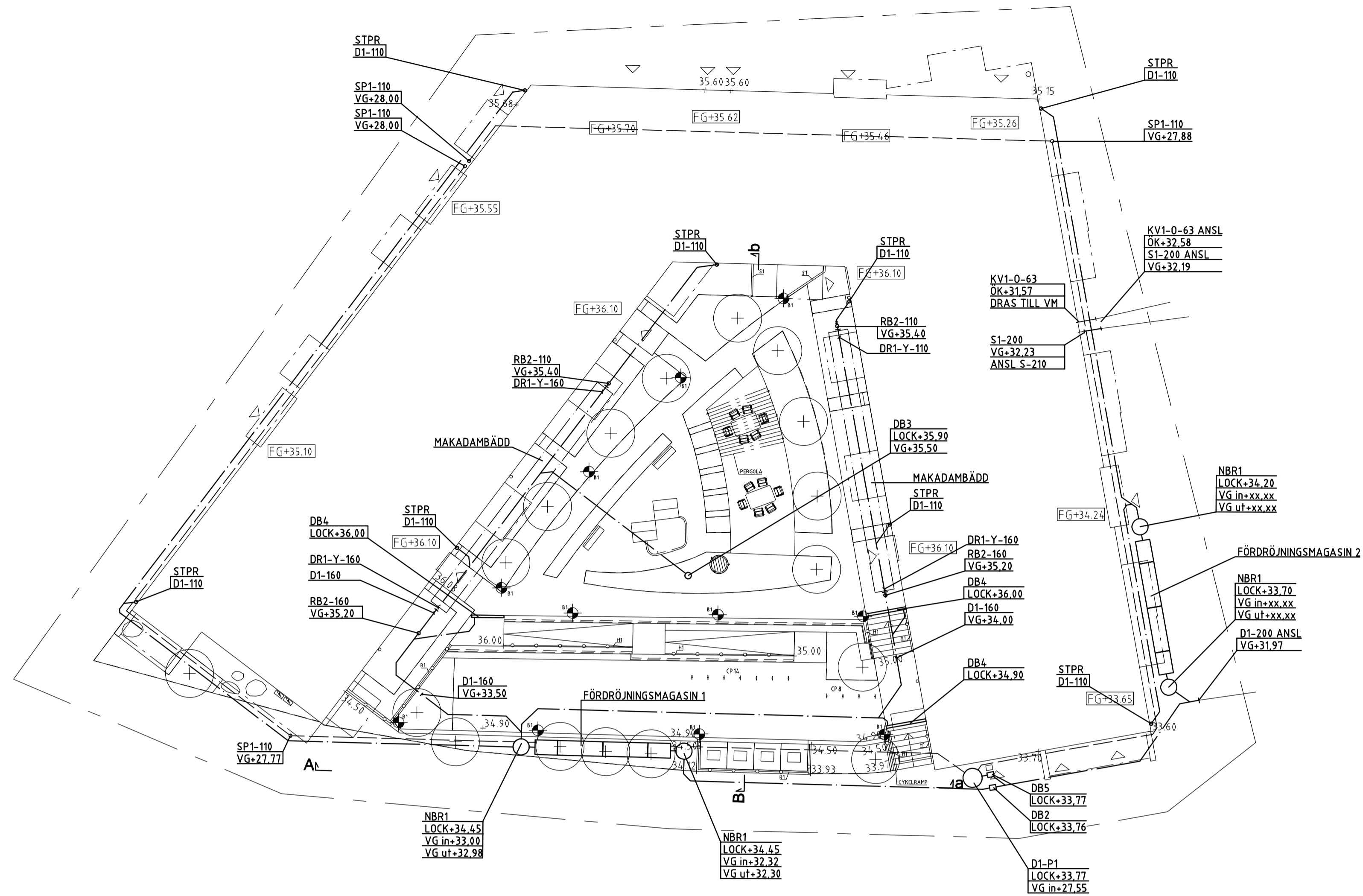

BET	ÄNDRINGEN AVSER	DATUM	SIGN
-----	-----------------	-------	------

RITNINGENS STATUS
BYGGLOVSHANDLING

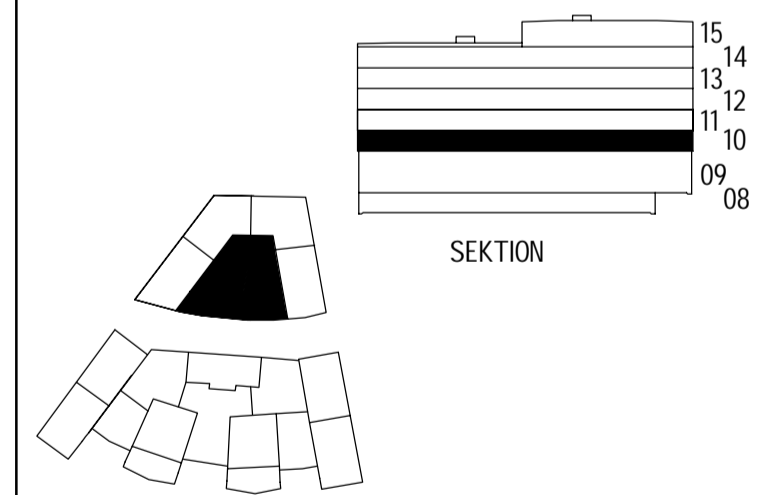

PEAB

FASTIGHET OCH PROJEKTNAMN
**KVARNHOLMSTERRASSEN
SICKLAÖN 38:27 - NYBYGGNAD BOSTÄDER**

A	TOTAL Arkitektur & Urbanism AB	TEL 08-441 36 00
K	Sören Lundgren Byggnads AB	TEL 08-706 45 50
V	TQI	TEL 08-567 021 00
VS	TQI	TEL 08-567 021 00
E	Elektrotrade Installation AB	TEL 08-514 911 84
L	ZOEN AB	TEL 0733-390 645

UPPDRAG NR 18006	RITAD/KONSTRUERAD AV NB	HANDLÄGGARE StTa
DATUM 2019-12-11	ANSVARIG StTa	

RITNINGENS INNEHÅLL
L4

**Yttre VA
Planritning**

SKALA A1/A3 A1 1:200 A3 1:400	RITNINGNUMMER R-51.1-60001	BET
---	--------------------------------------	-----

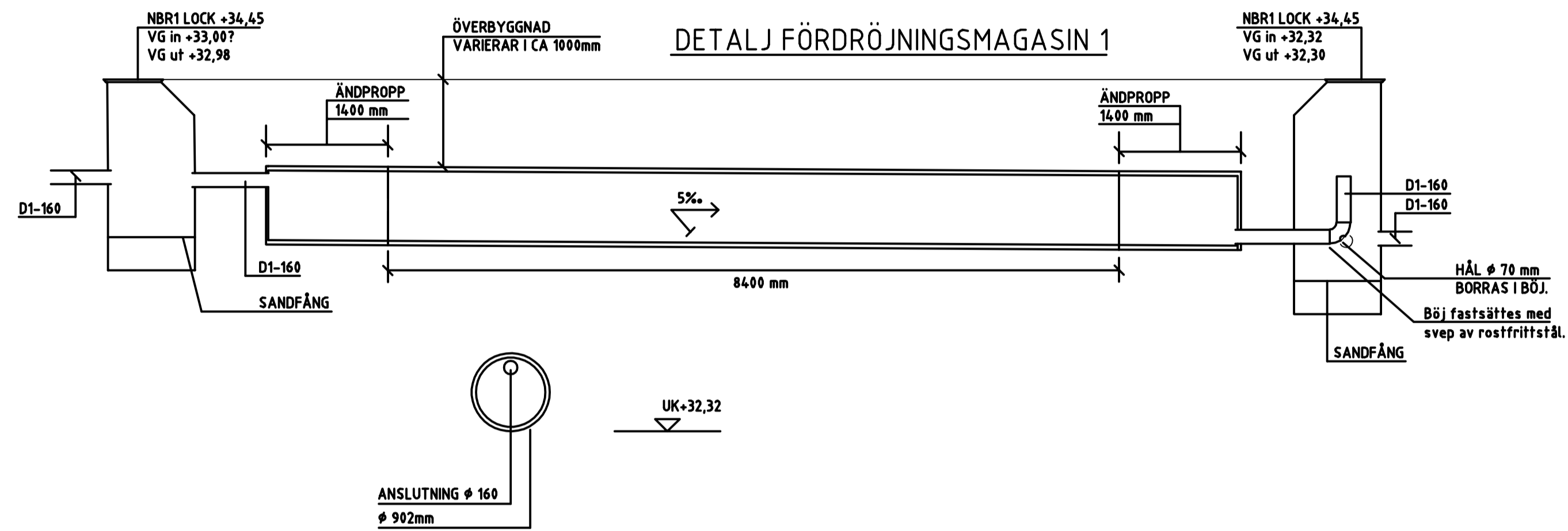

DETALJ MAKADAMBÄDD

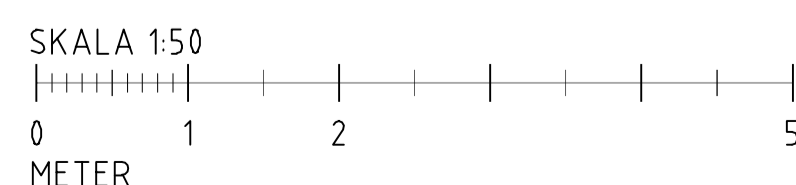
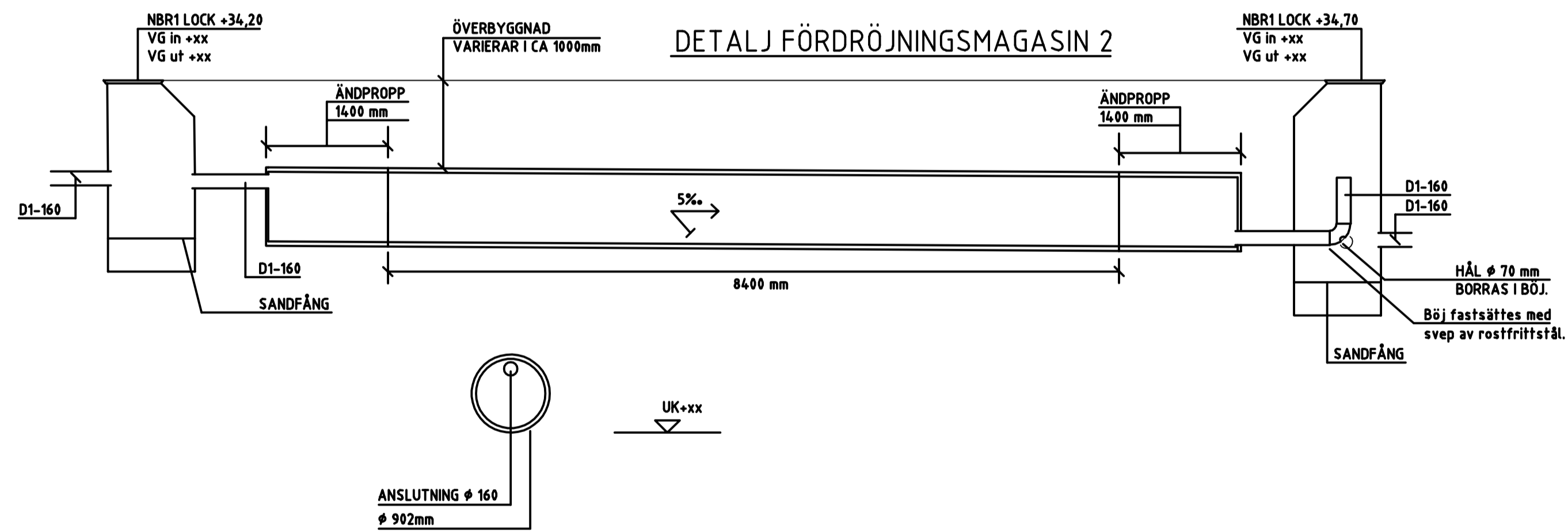
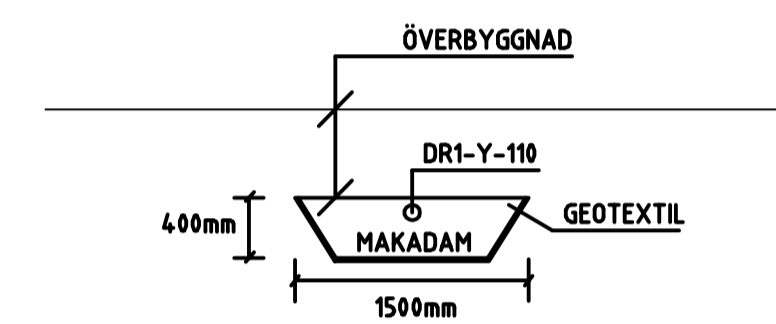

BET	ÄNDRINGEN AVSER	DATUM	SIGN
RITNINGENS STATUS			
BYGGLOVSHANDLING			
			15 14 13 12 11 10 09 08
PEAB			
FASTIGHET OCH PROJEKTNAMN			
Kvarnholmsterrassen			
SICKLAÖN 38:27 - NYBYGGNAD BOSTÄDER			
A	TOTAL Arkitektur & Urbanism AB	TEL 08-441 36 00	
K	Sören Lundgren Byggnads AB	TEL 08-706 45 50	
V	TQI	TEL 08-567 021 00	
VS	TQI	TEL 08-567 021 00	
E	Elektrotrade Installation AB	TEL 08-514 911 84	
L	ZOEN AB	TEL 0733-390 645	
UPPDRAG NR	RITAD/KONSTRUERAD AV	HANDLÄGGARE	
18006	NB	StTa	
DATUM	ANSVARIG		
2019-12-11	StTa		
RITNINGENS INNEHÅLL			
L4			
Yttre VA			
Detaljer fördröjningsmagasin			
SKALA A1/A3	RITNINGNUMMER	BET	
A1 1:50	R-51.2-60001		
A3 1:100			

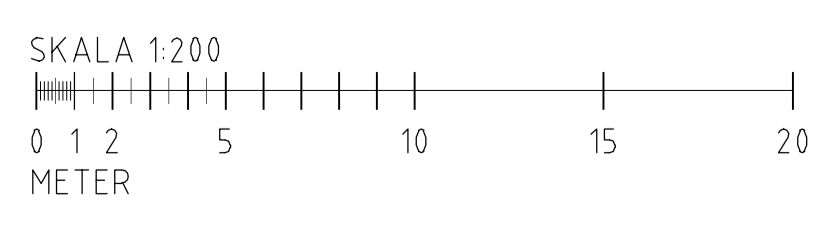
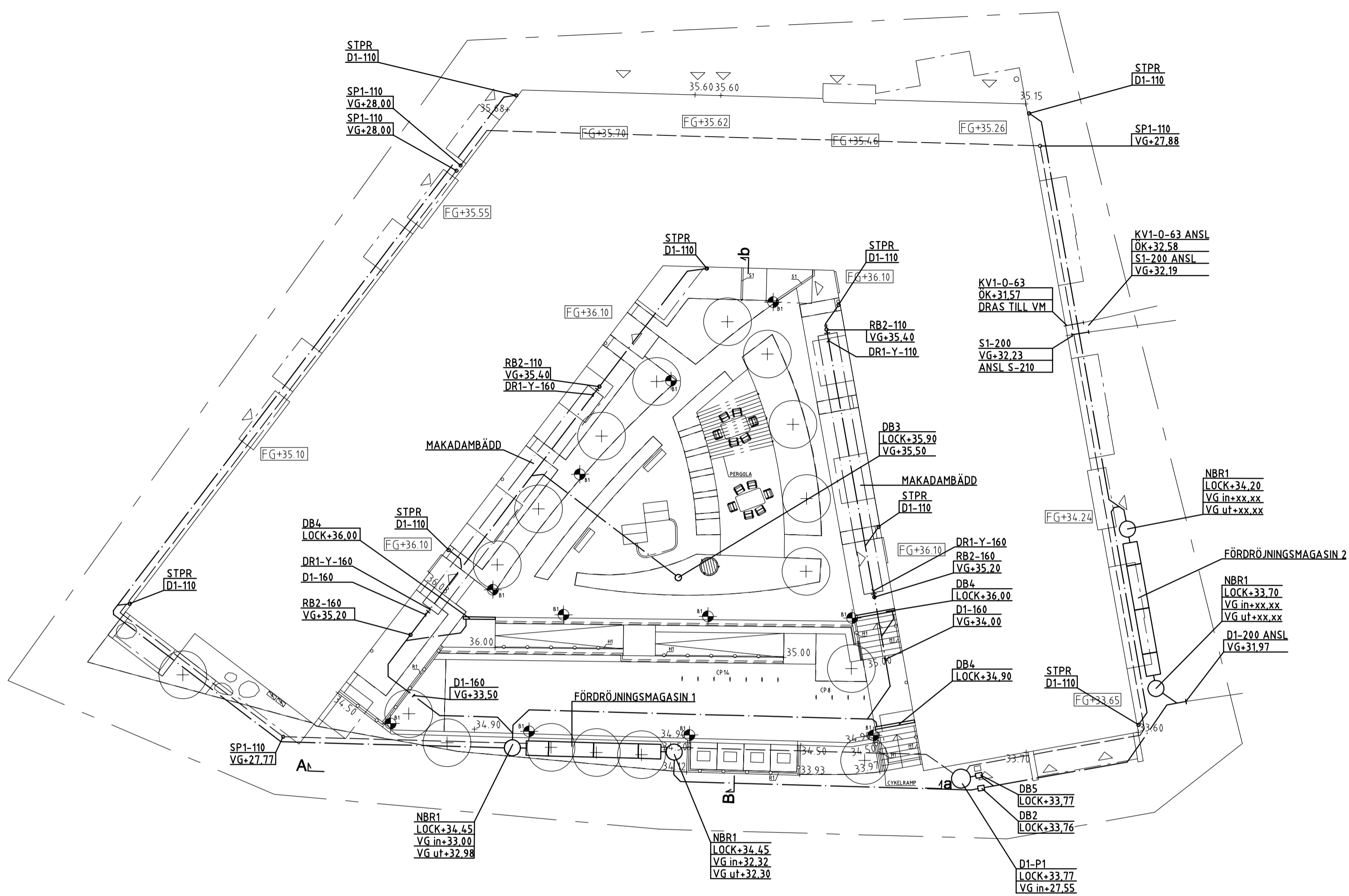

BET	ÄNDRINGEN AVSER	DATUM	SIGN
-----	-----------------	-------	------

RITNINGENS STATUS
BYGGLOVSHANDLING

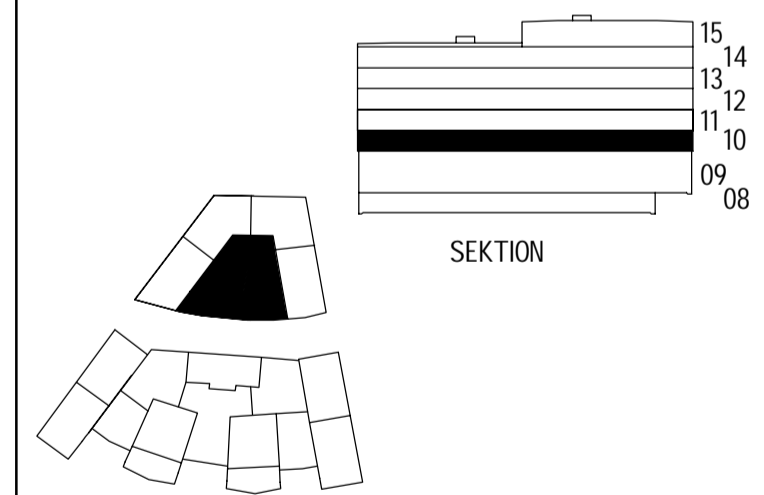

FASTIGHET OCH PROJEKTNAMN
**KVARNHOLMSTERRASSEN
SICKLAÖN 38:27 - NYBYGGNAD BOSTÄDER**

A	TOTAL Arkitektur & Urbanism AB	TEL 08-441 36 00
K	Sören Lundgren Byggnads AB	TEL 08-706 45 50
V	TQI	TEL 08-567 021 00
VS	TQI	TEL 08-567 021 00
E	Elektrotrade Installation AB	TEL 08-514 911 84
L	ZOEN AB	TEL 0733-390 645

UPPDRAGS NR 18006	RITAD/KONSTRUERAD AV NB	HANDLÄGGARE StTa
DATUM 2019-12-11	ANSVARIG StTa	

RITNINGENS INNEHÅLL
L4

**Yttre VA
Planritning**

SKALA A1/A3 A1 1:200 A3 1:400	RITNINGNUMMER R-51.1-60001	BET
-------------------------------------	--------------------------------------	-----