

A1

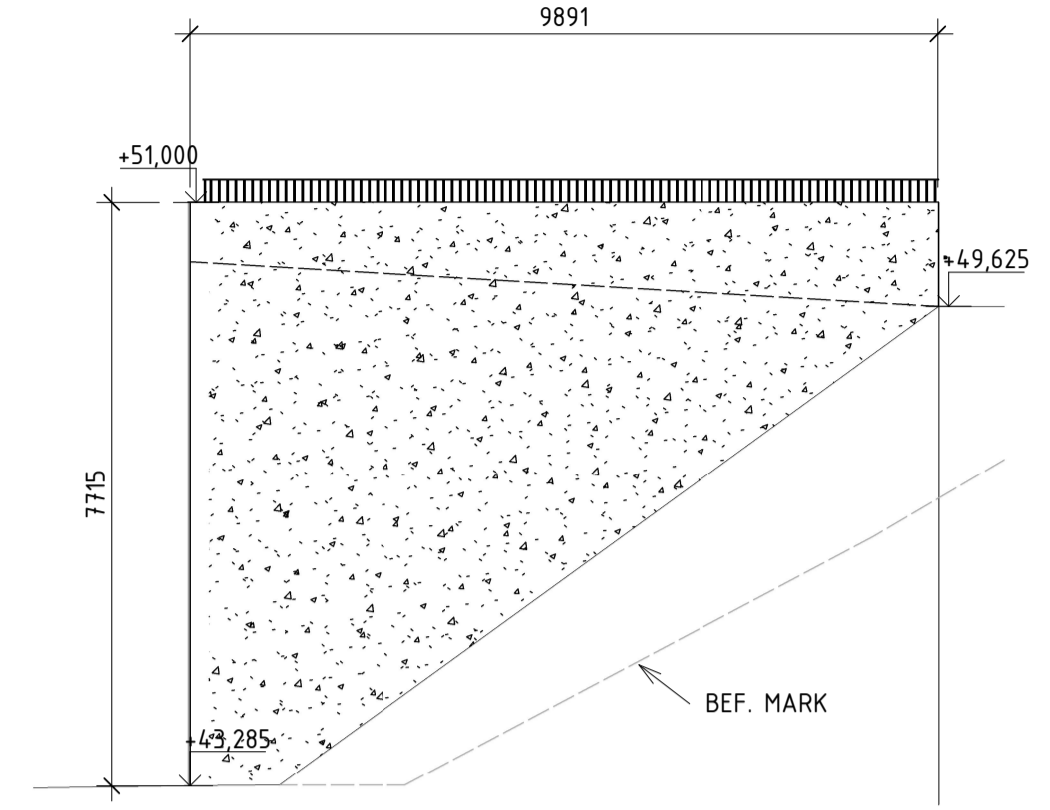

A2

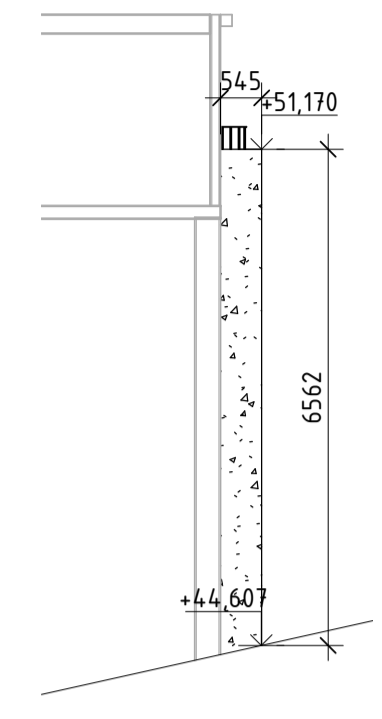

B1

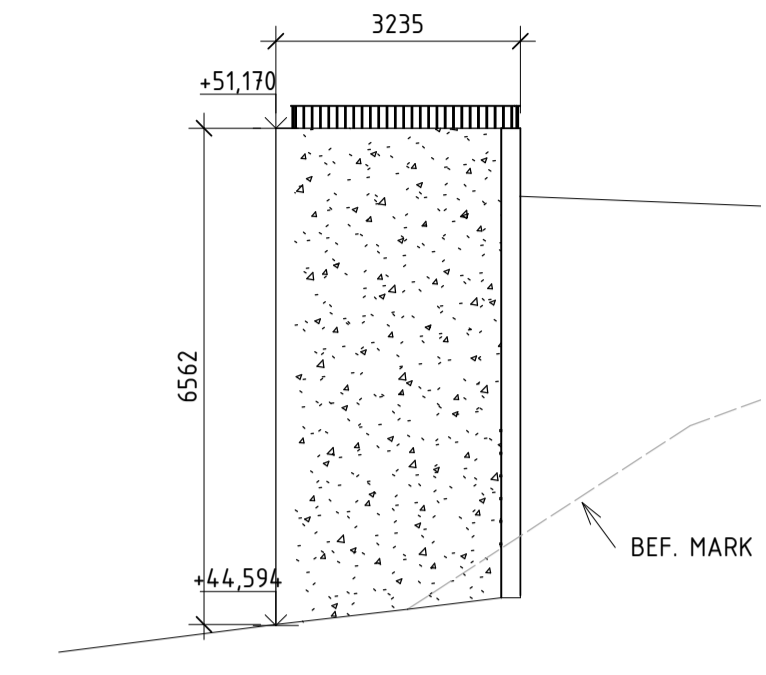

B2

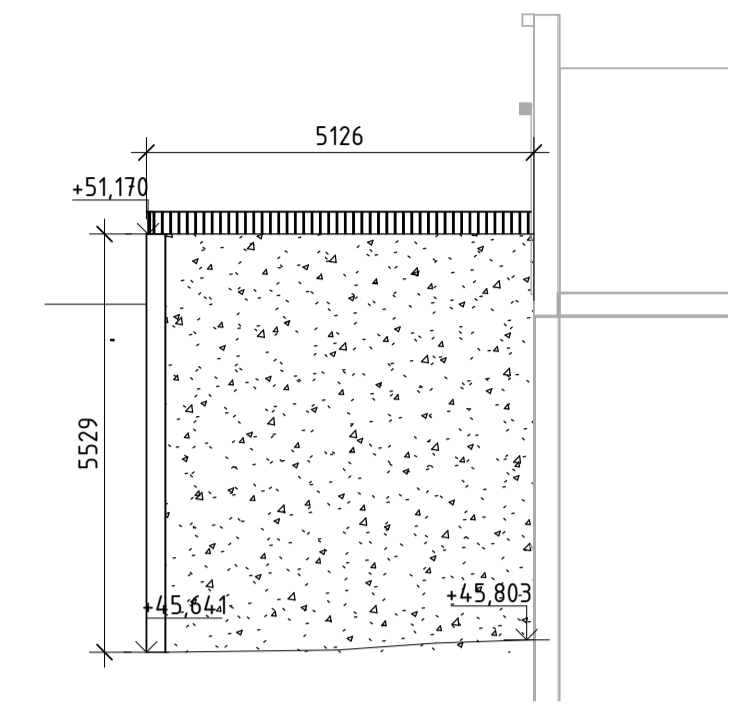

B3

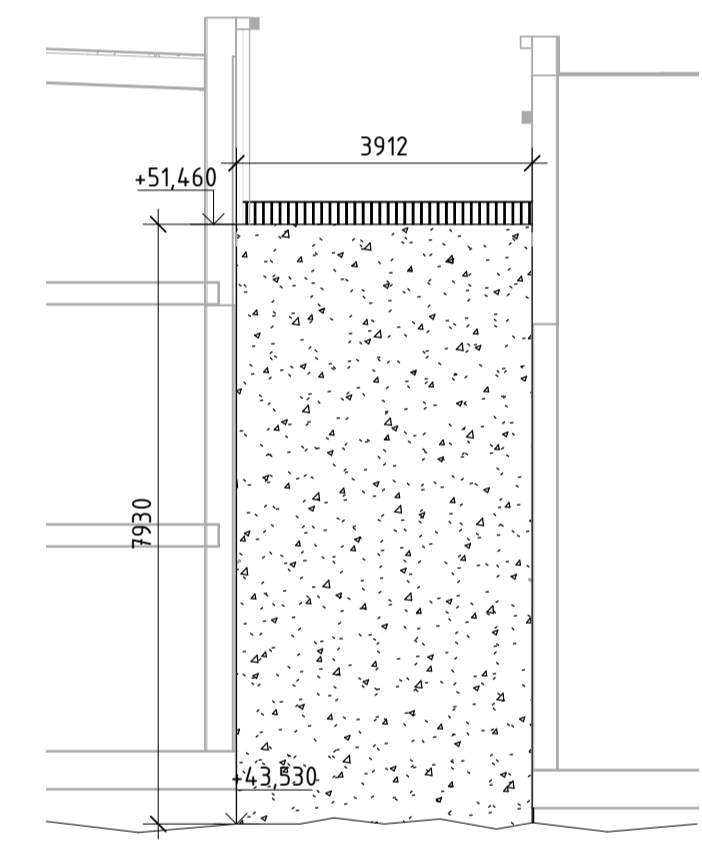

C1

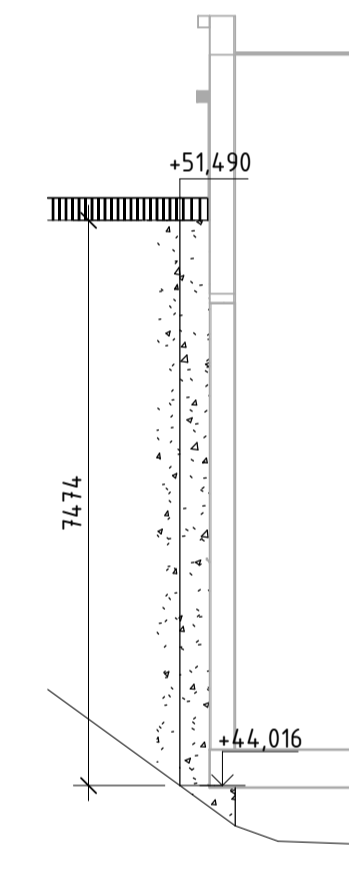

D1

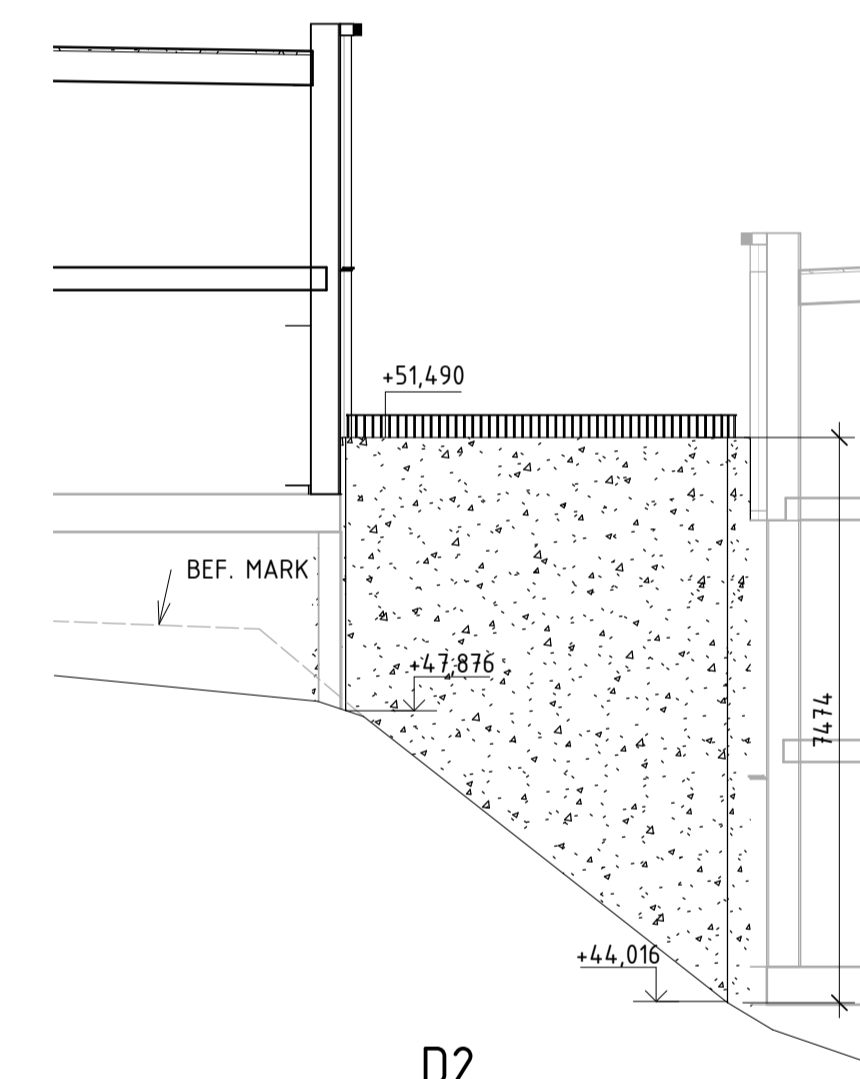

D2

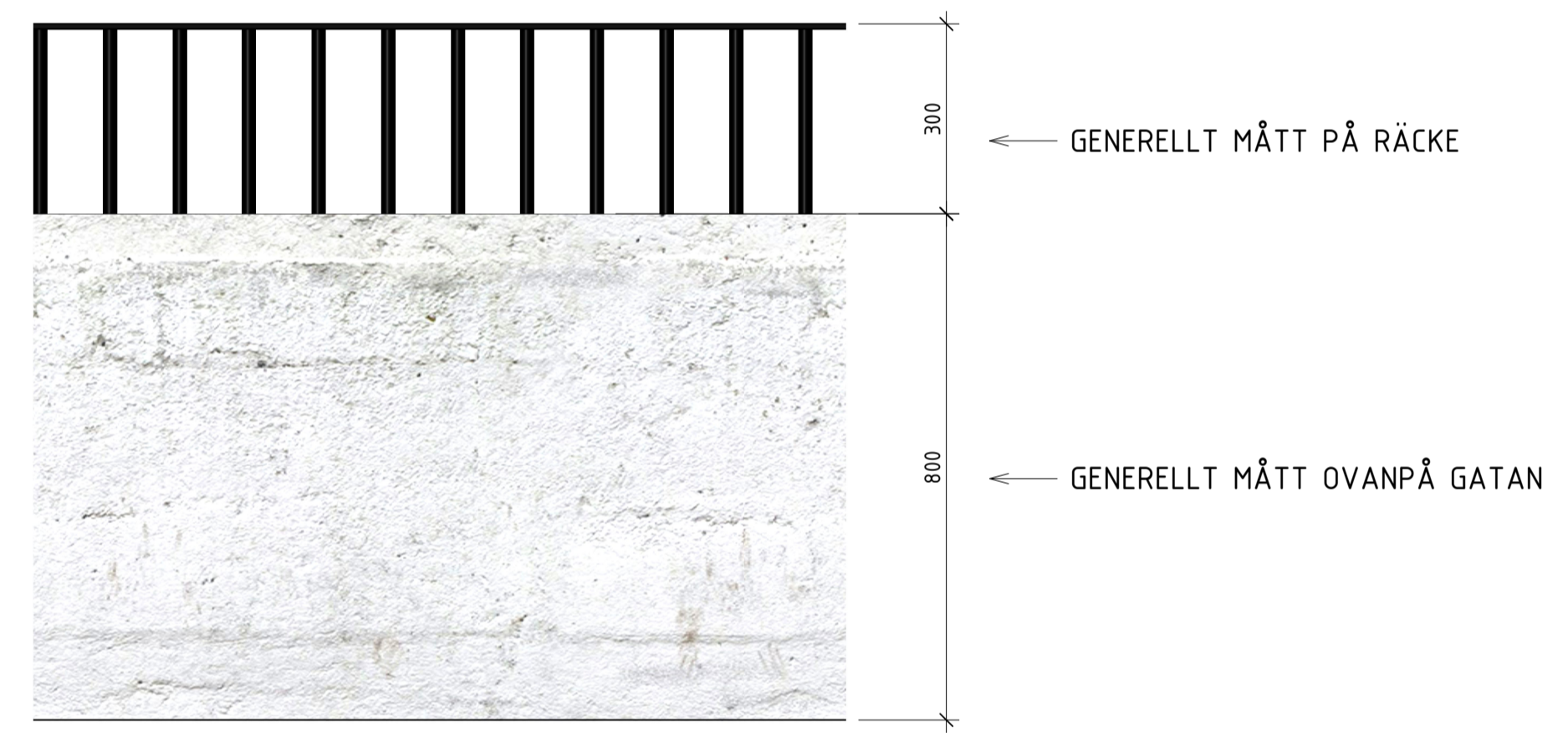

DETALJ A-A  
SKALA 1:10 (A1)

ANMÄRKNING:  
ALLA STÖDMURAR UTFÖRS I GRÅ BETONG.  
PLATSGJUTES.

PINNRÄCKE-KULÖR:SVART



STÖDMURAR KLÄS MED VEGETATION I DE LÄGEN DÄR DE EXPONERAS MOT FARLEDEN.  
VEGETATION: EXEMPEL-MURGRÖNA.

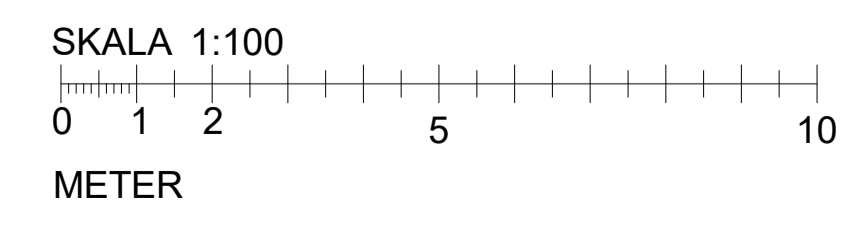

A	ANDRINGAR ENL. PM A-3	2020-04-03	MASA
BET	ANDRINGEN AVSER	DATUM	SIGN
LOKALISERINGSFIGUR			
			N
SEGELVYN			
BYGGLOVSHANDLING			
<b>ALM</b>			
A	2A Teknik & Arkitektur	08-586 303 00	
K	-	-	
VS	-	-	
V	-	-	
EL	-	-	
Pr	-	-	
UPPDRAG NR	RITAD AV	HANDLAGGARE	
80539	PEEL	AGE	
DATUM	ANSVARIG	-	
2020-01-31	AGE	-	
SEGELVYN			
UPPSTÄLLNINGSRITNING			
ELEVATIONER STÖDMURAR			
SKALA	NUMMER	BET	
A1 1:100	A-01.1-161	A	
A3 1:200			

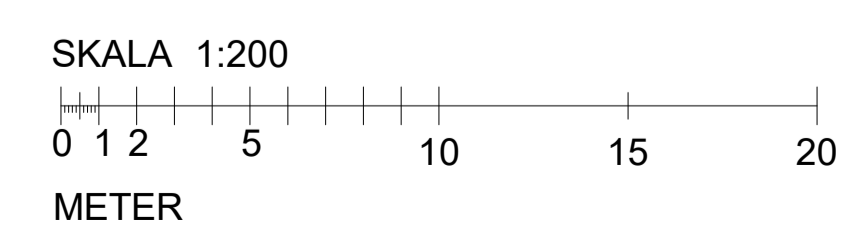
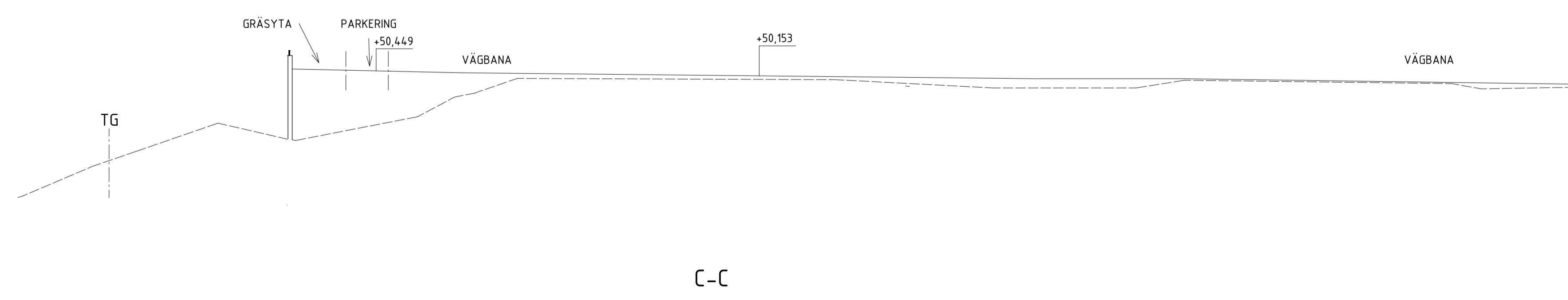
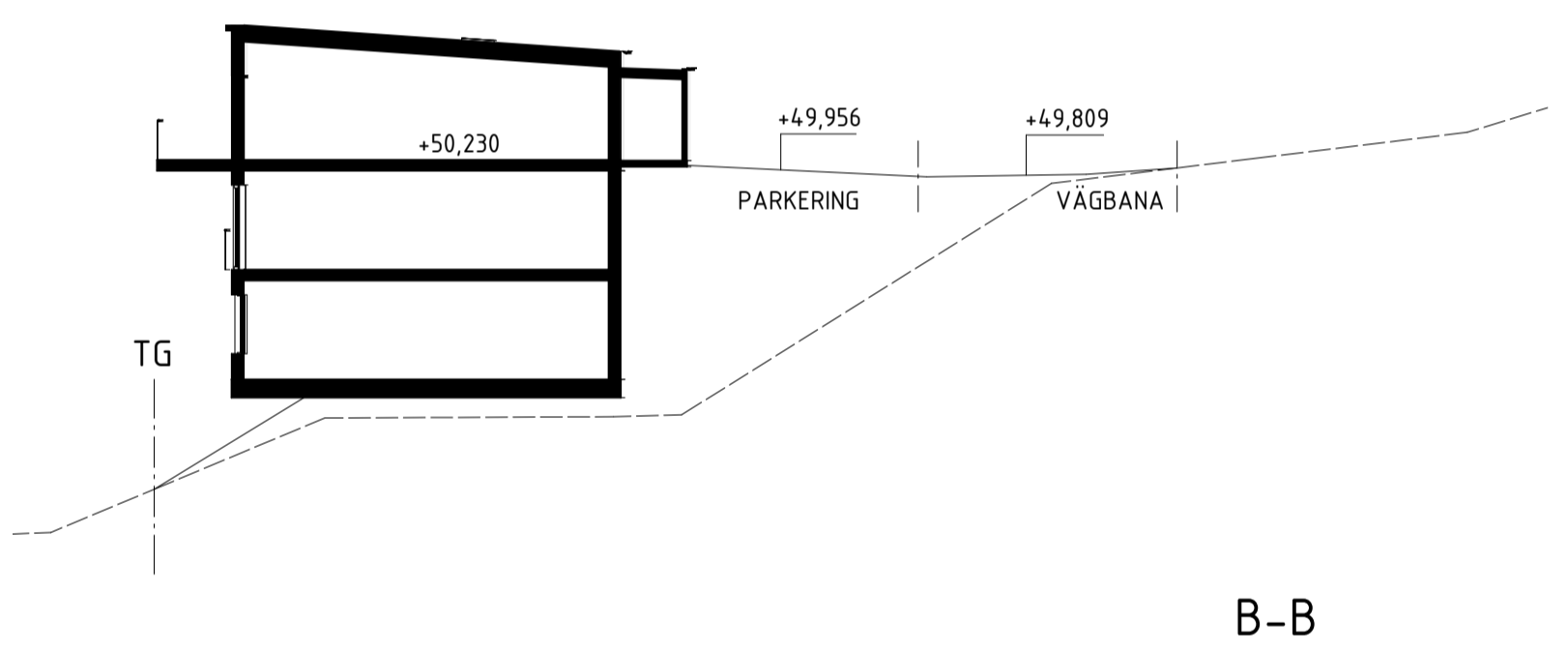
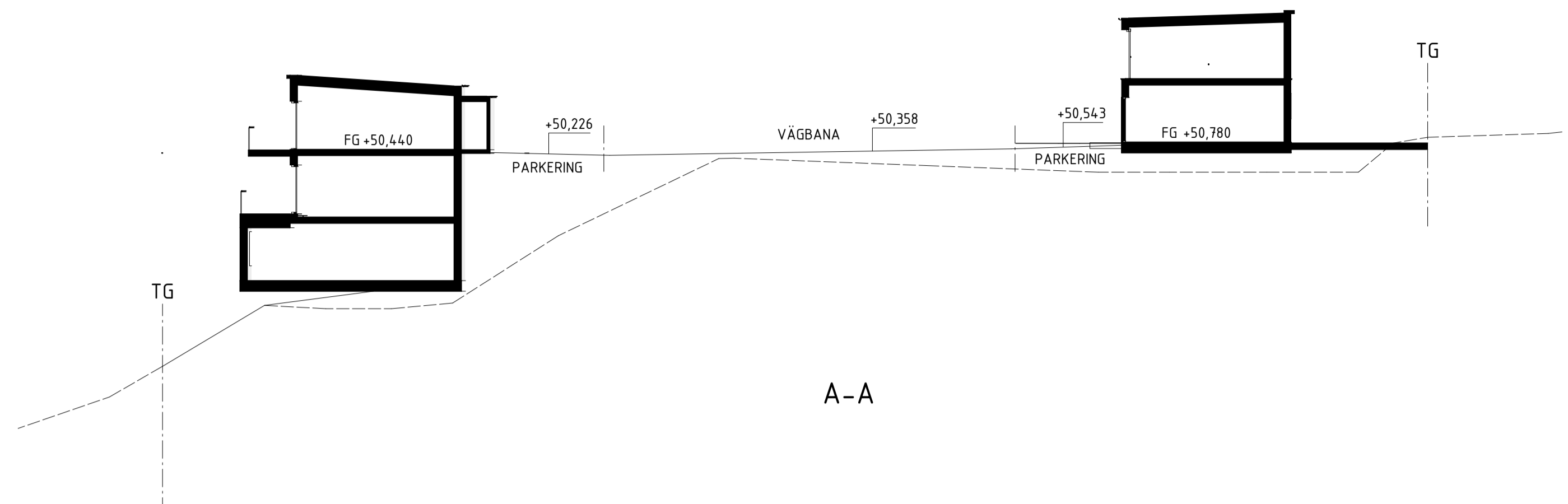

A	ANDRINGAR ENL. PM A-3	2020-04-03	MÅSA
BET	ANDRINGEN AVSER	DATUM	SIGN

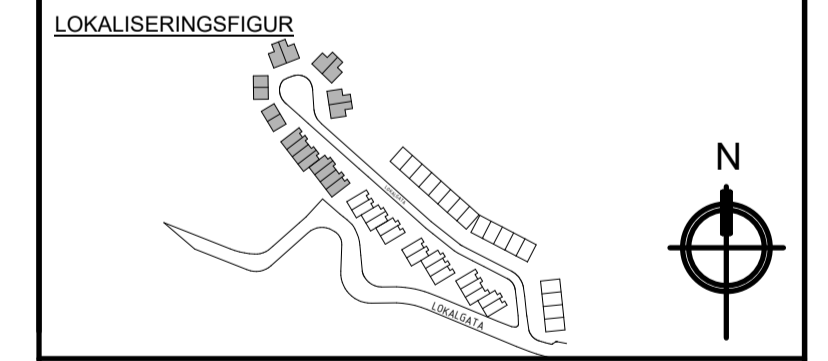

SEGELVYN

BYGGLOVSHANDLING



A	2A Teknik & Arkitektur	08-586 303 00
K	-	-
VS	-	-
V	-	-
EL	-	-
Pr	-	-

UPPDRAG NR	RITAD AV	HANDLAGGARE
80539	PEEL	AGE
DATUM	ANSVARIG	
2020-01-31	AGE	

SEGELVYN

MARKSEKTIONER A-A B-B C-C	
SKALA	NUMMER
A1 1:200	A-40.1-171
A3 1:400	A



FÖRKLARINGAR:

- +0,00 PROJEKTERADE HÖJDER
- ASFALTERAD YTA
- PLATTOR
- GRÄSARMERING
- ENTRÉANVISNING
- STÖDMUR
- MK+0,00 MURKRÖNSHÖJD
- PL POSTLÅDA
- SA AVFALL  
MINST MÅTT TILL GATAN  
ÄR 0,5 M.
- N NATUROMRÅDE

B	ÄNDRINGAR ENL. PM A-4	2020-05-25	MASA
A	ÄNDRINGAR ENL. PM A-3	2020-04-03	MASA
BET	ÄNDRINGEN AVSER	DATUM	SIGN

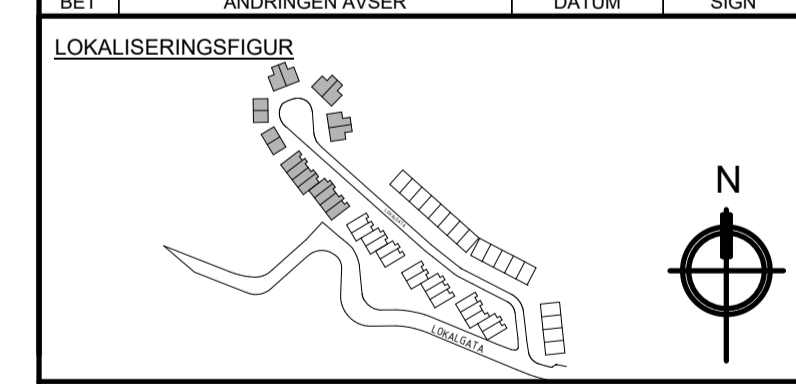

SEGELVYN

BYGGLOVSHANDLING



A	2A Teknik & Arkitektur	08-586 303 00
K	-	-
VS	-	-
V	-	-
EL	-	-
Pr	-	-

UPPDRAG NR	RITAD AV	HANDLAGGARE
80539	MASA	AGE
DATUM	ANSVARIG	
2020-01-31	AGE	

SEGELVYN	
MARKPLANERINGSRITNING	
SKALA	NUMMER
A1 1:200	A-01.1-150
A3 1:400	B

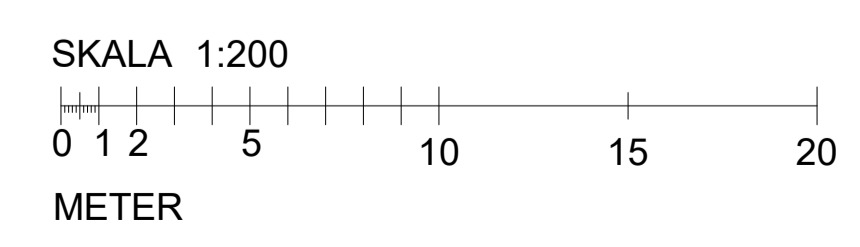

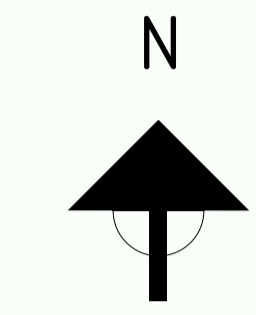
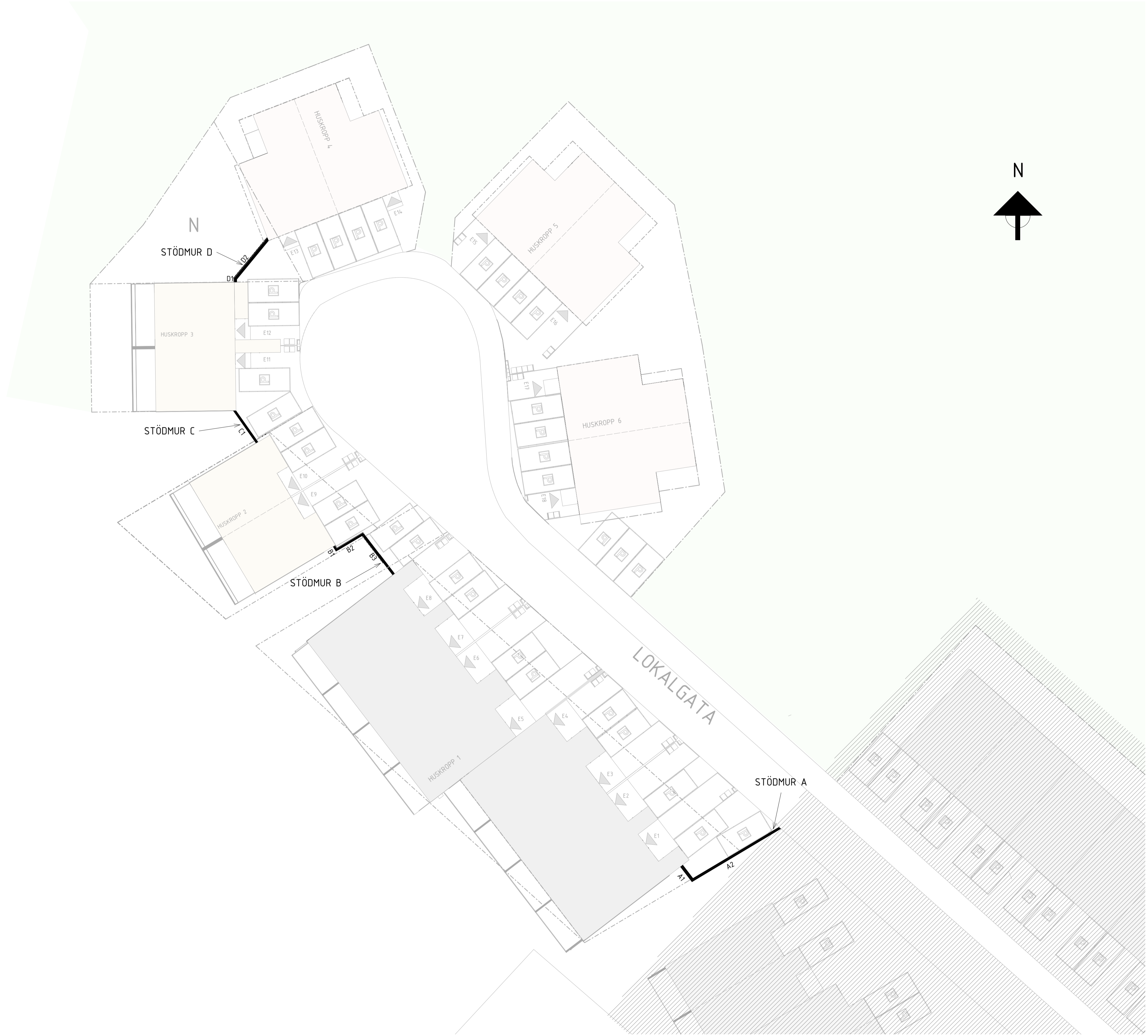

B	ÄNDRINGAR ENL PM A-4	2020-05-25	MASA
A	ÄNDRINGAR ENL PM A-3	2020-04-03	MASA
BET	ÄNDRINGEN AVSER	DATUM	SIGN

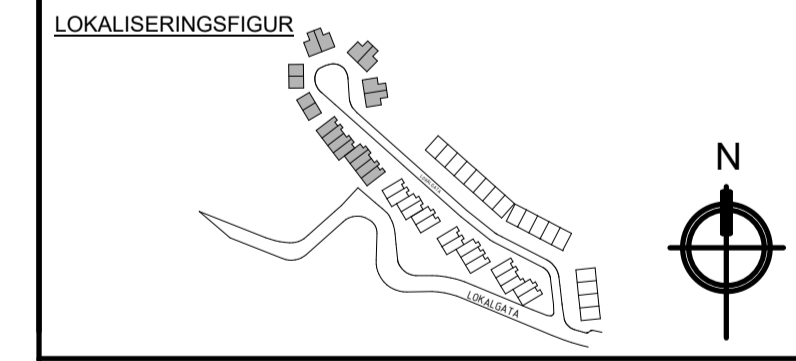

SEGELVYN

BYGGLOVSHANDLING

**ALM**

A	2A Teknik & Arkitektur	08-586 303 00
K	-	-
VS	-	-
V	-	-
EL	-	-
Pr	-	-

UPPDRAG NR	RITAD AV	HANDLAGGARE
80539	PEEL	AGE
DATUM	ANSVARIG	
2020-01-31	AGE	

SEGELVYN		
SITUATIONSPLAN STÖDMURAR		
SKALA	NUMMER	BET
A1 1:200	A-01.1-160	B
A3 1:400		

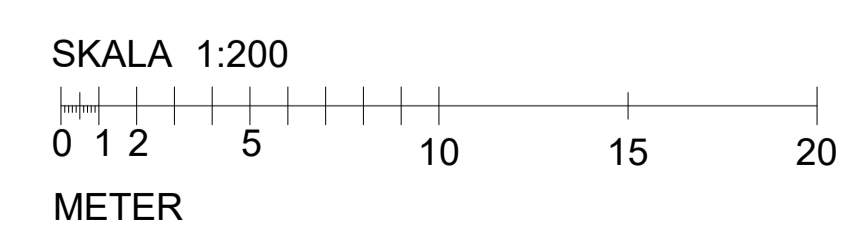

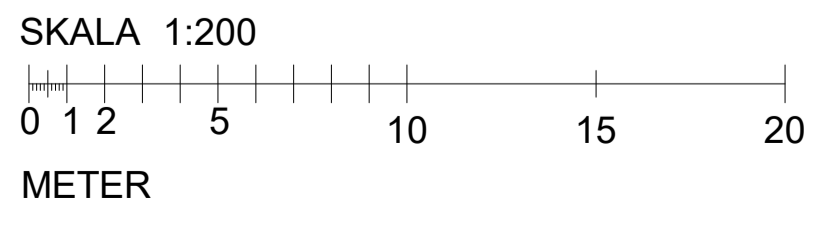
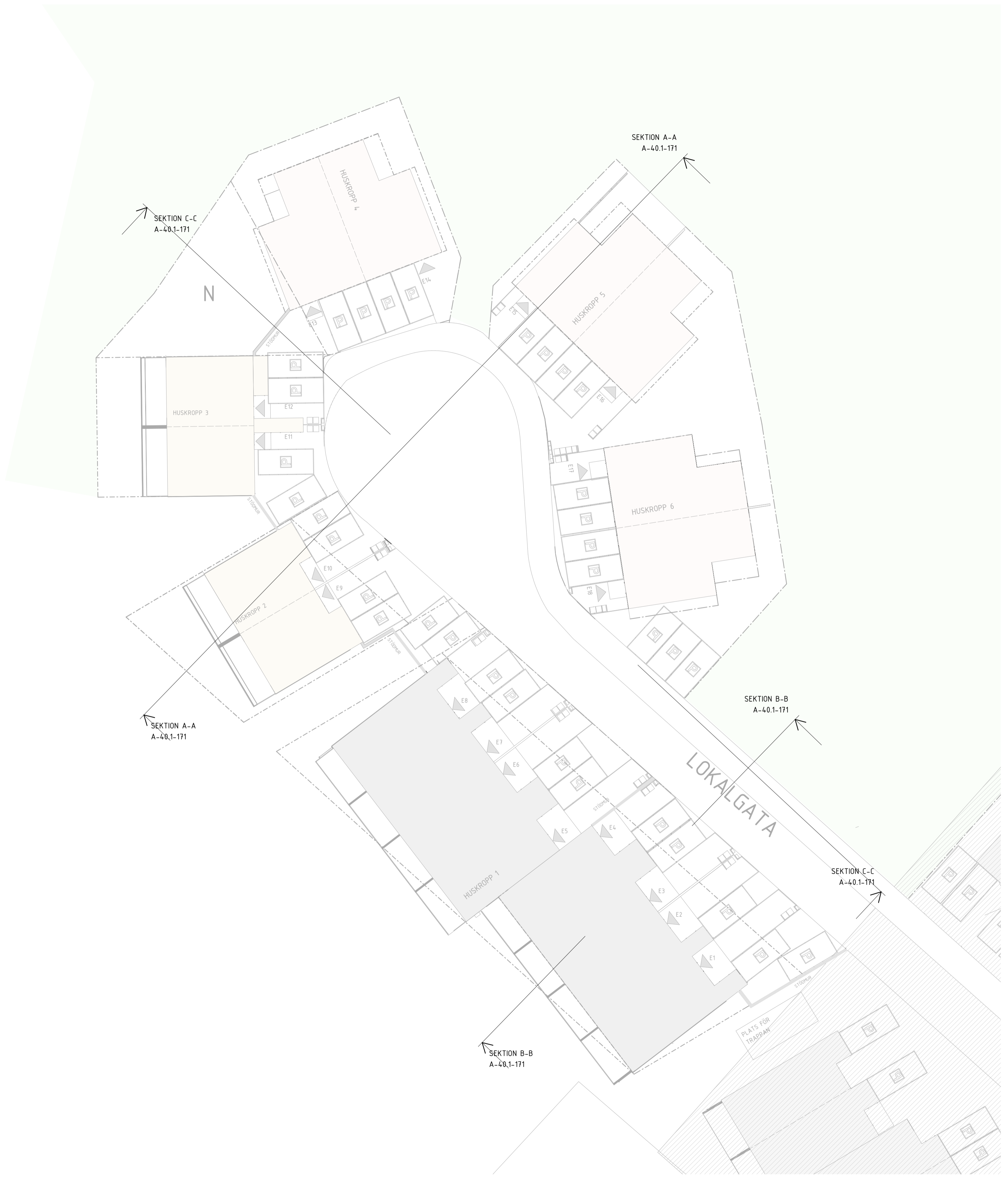

B	ANDRINGAR ENL. PM A-4	2020-05-25	MASA
A	ANDRINGAR ENL. PM A-3	2020-04-03	MASA
BET	ANDRINGEN AVSER	DATUM	SIGN

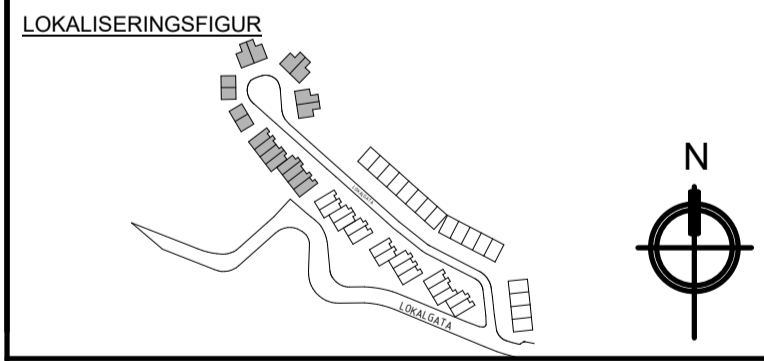

SEGELVYN

BYGGLOVSHANDLING

# ALM

A	2A Teknik & Arkitektur	08-586 303 00
K	-	-
VS	-	-
V	-	-
EL	-	-
Pr	-	-

UPPDRAG NR	RIKAD AV	HANDLAGGARE
80539	PEEL	AGE
DATUM	ANSVARIG	
2020-01-31	AGE	

SEGELVYN

SITUATIONSPLAN, MARKSEKTIONER	
SKALA	NUMMER
A1 1:200	A-40.1-170
A3 1:400	B