

Ungefärlig tornplacering i RT90 X=6579595, Y=1637966

SITUATIONSPLAN

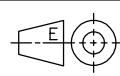

Uppgjord	Vinnergi		Oskar Eriksson
Dokansv/Godk	Net4Mobility	Datum	2022-12-23
Referenser	N4M T331115.2 - Björknäs Nacka		I Rev
	Produktbenämning		C
	Björknäs 1:851		
	Nacka		
Skala	Format	Dokumentnr	Blad
1:2000	A4	T331115.2	1 (2)

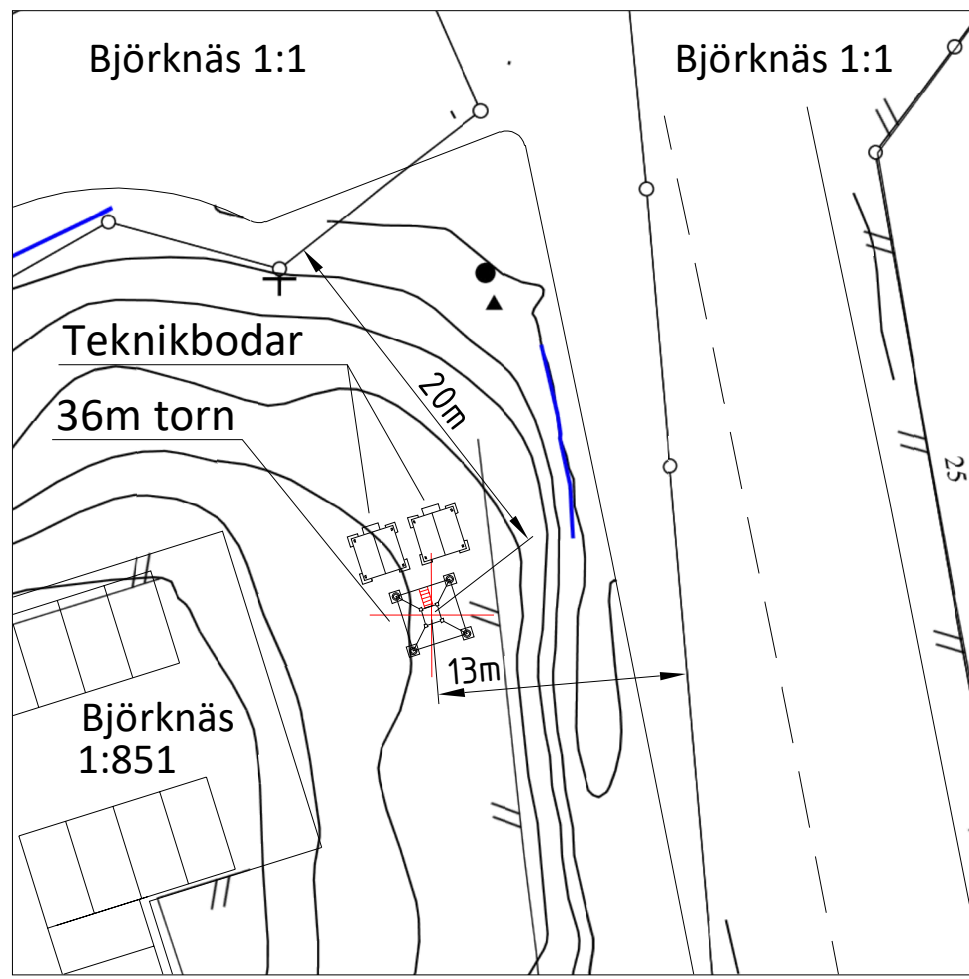

Ungefärlig tornplacering i RT90 X=6579595, Y=1637966

SITUATIONSPLAN

 	Uppgjord	Vinnergi		Oskar Eriksson	
	Dokansv/Goak	Net4Mobility		Datum	I Rev
Referenser	Produktbenämning		2022-12-23		C
N4M T331115.2 - Björknäs Nacka	Björknäs 1:851				
	Nacka				
Skala	Format	Dokumentnr	Blad		
1:400	A4	T331115.2	2 (2)		

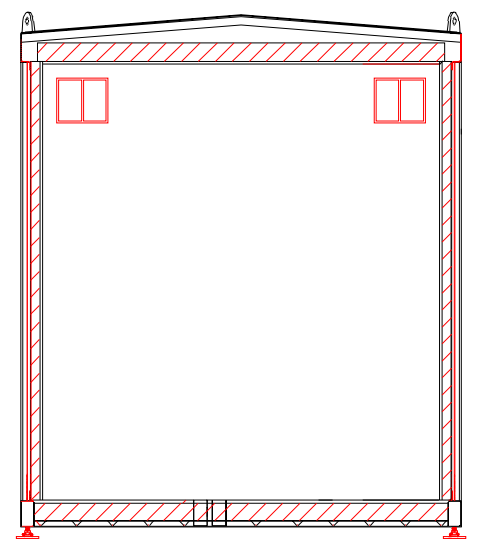
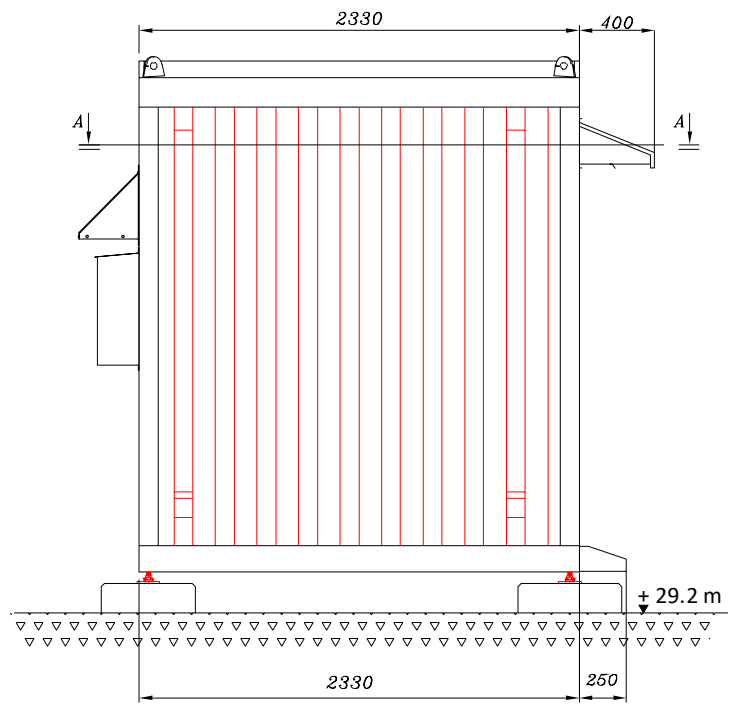
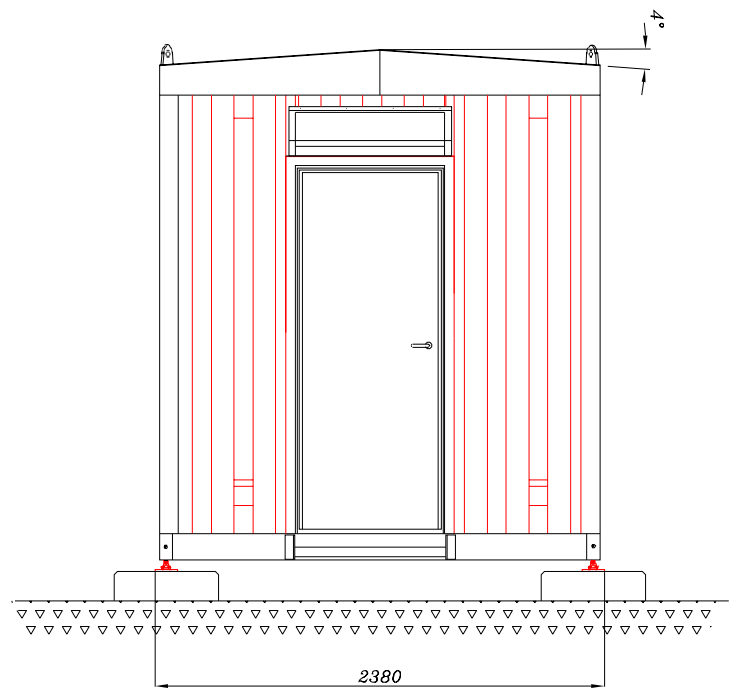

Snitt B-B

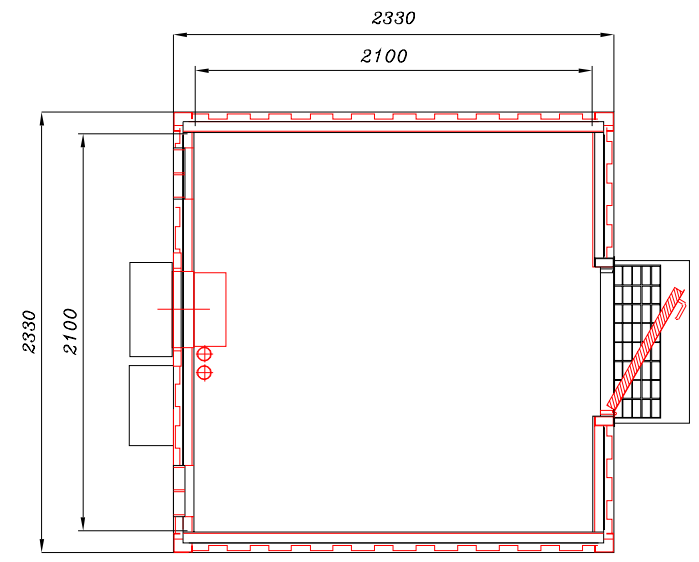
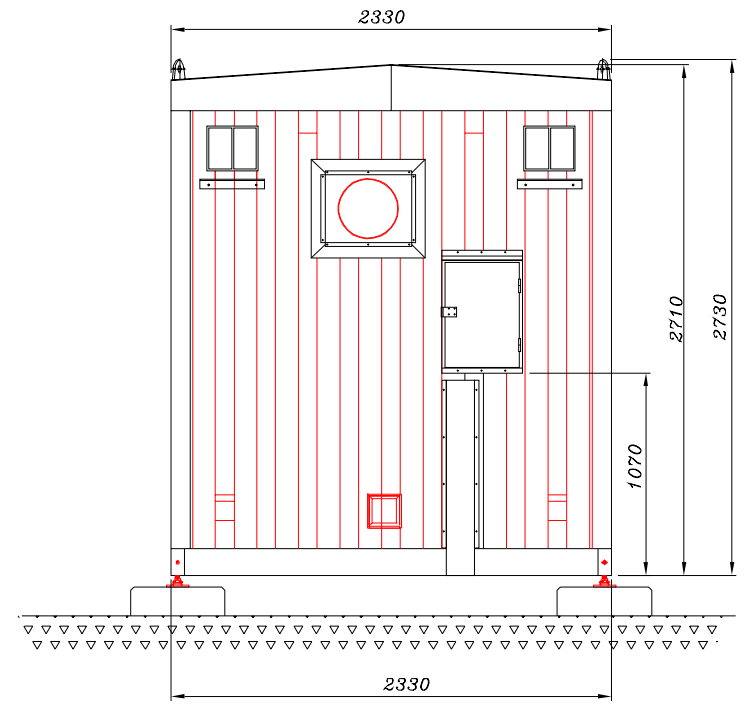
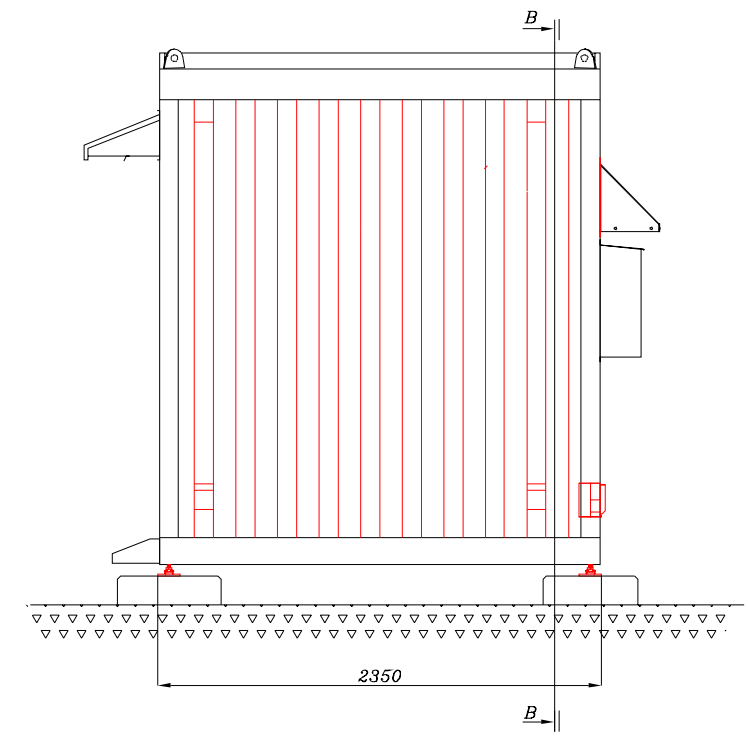

Snitt A-A

Färgsättning
 Plåtfasad: NCS 2502-B
 Plåttak: NCS S9000- N

	Uppgjord	Oskar Eriksson	
	Vinnergi	Dokumentnr	2023-02-08 C
Referenser	N4M T331115.2 - Björknäs Nacka	Produktbenämning	Teknikbod
Skala	1:40	Inplacering vid torn	
Format	A3	Dokumentnr	TEKNIKOD TB4
		Blad	1(1)

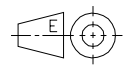
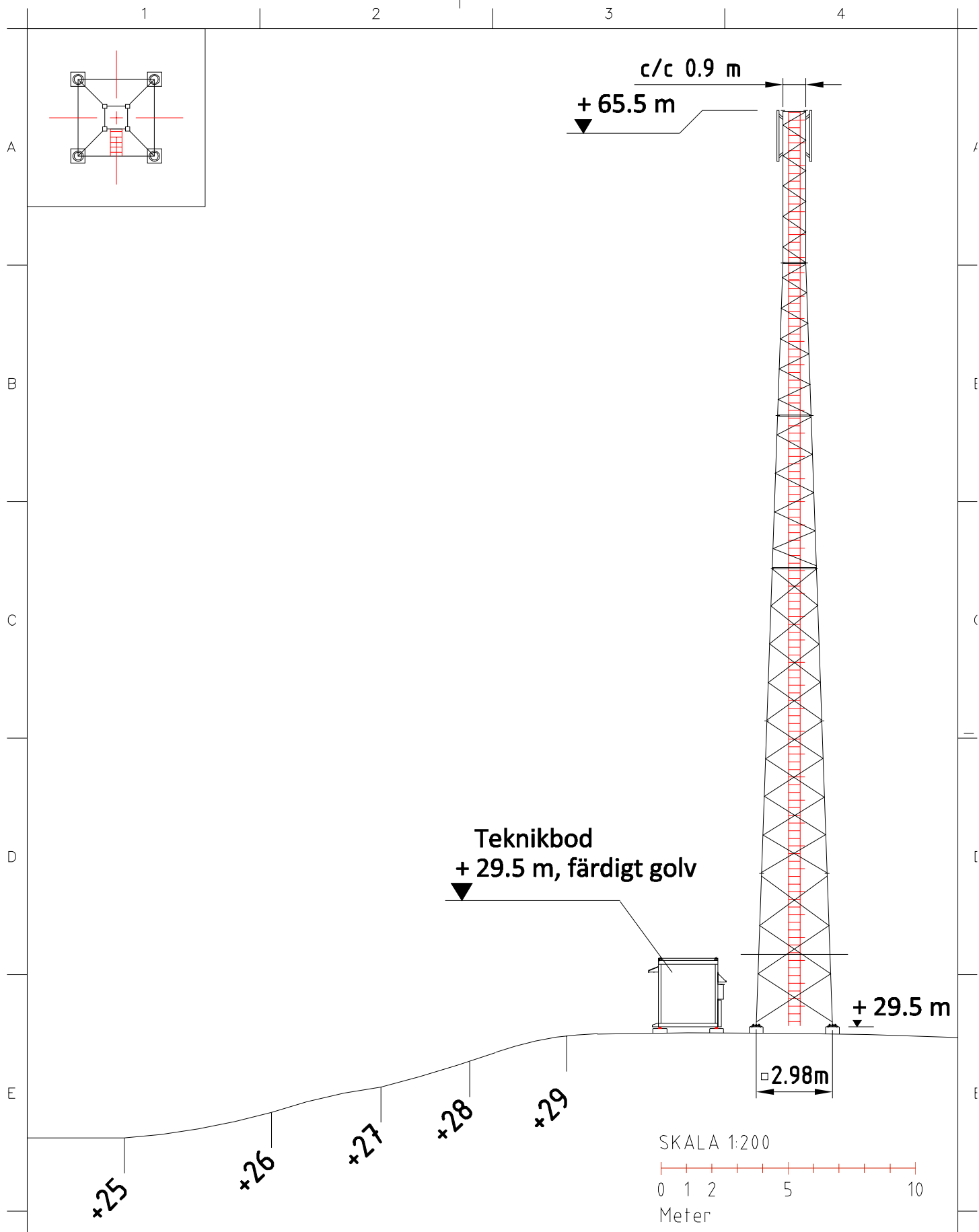

F	Uppgjord	Vinnergi		Oskar Eriksson	
	Dokansv/Godk	Net4Mobility		Datum	I Rev
	Referenser	N4M T331115.2 - Björknäs Nacka		2023-02-08	B
	Skala	Format		Dokumentnr	Blad
	1:200	A4		Torn3	1 (1)